

## Sestava RCF CX15N351

**Osazení:**

**- RCF CX15N351**

<http://eshop.prodance.cz/DetailPage.asp?DPG=90315>

**Schémata výhybek:**

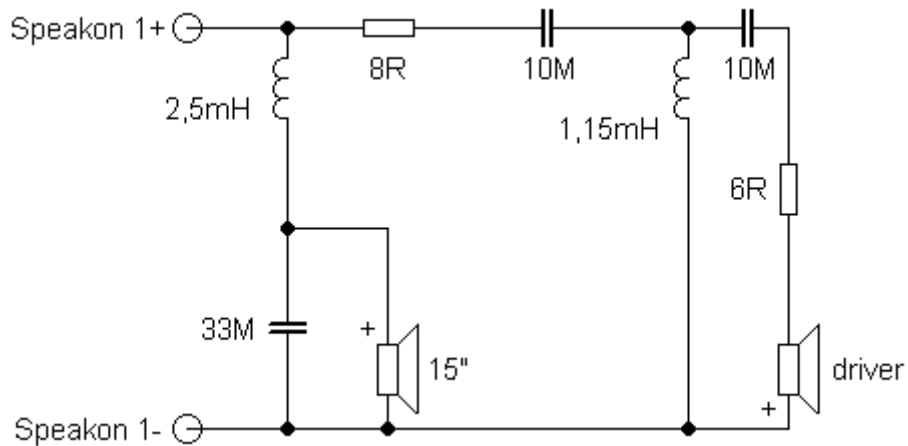

**varianta I.**

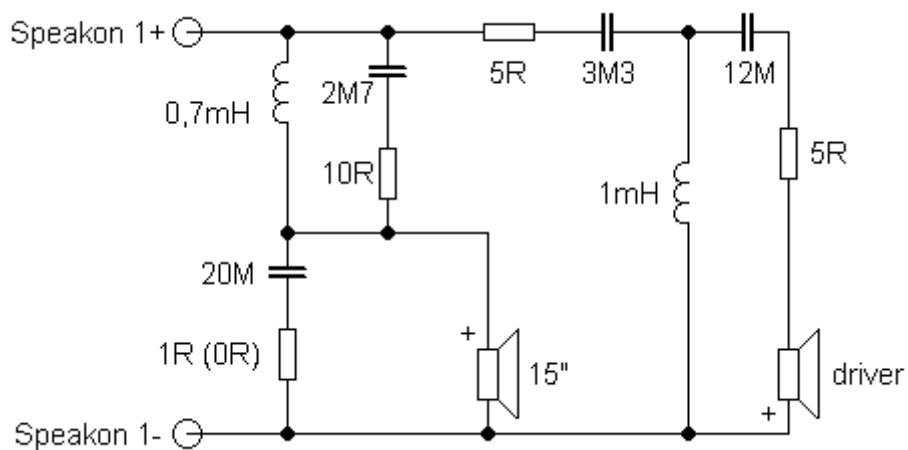

**varianta II. (lepší) s alternativním odporem 1R**

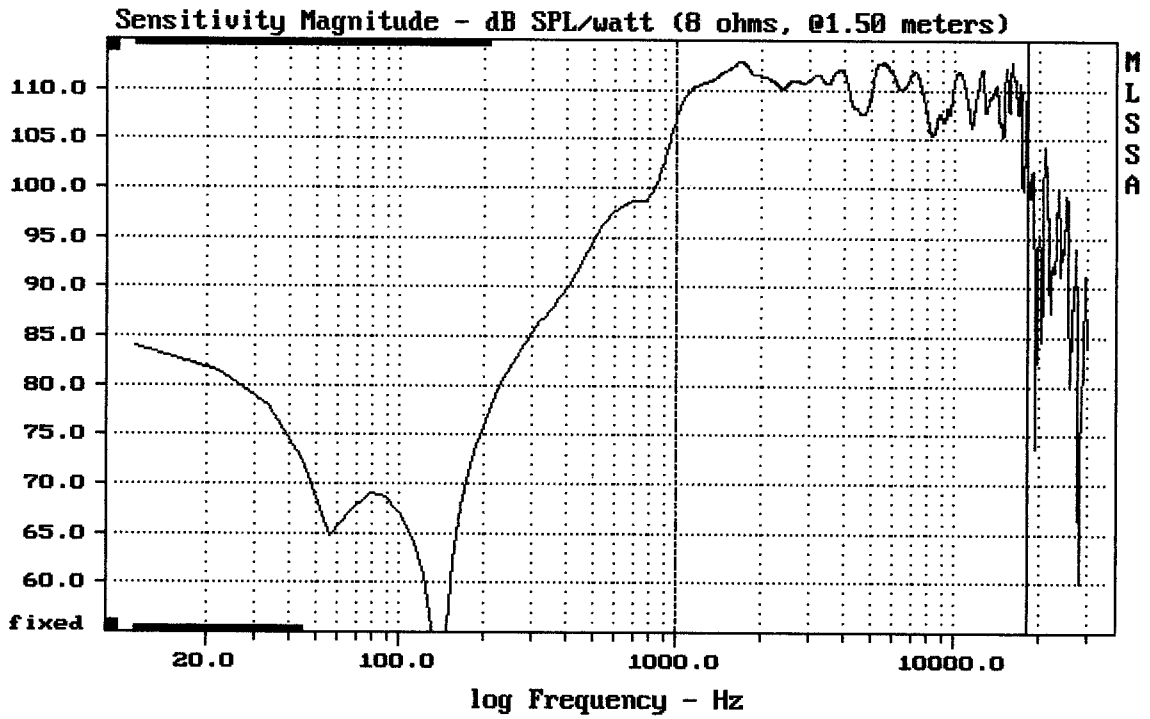

Level (999:18200 Hz) = 110.56 dB SPL/watt (8 ohms, @1.50 meters)

CX15N351

MLSSA: Frequency Domain

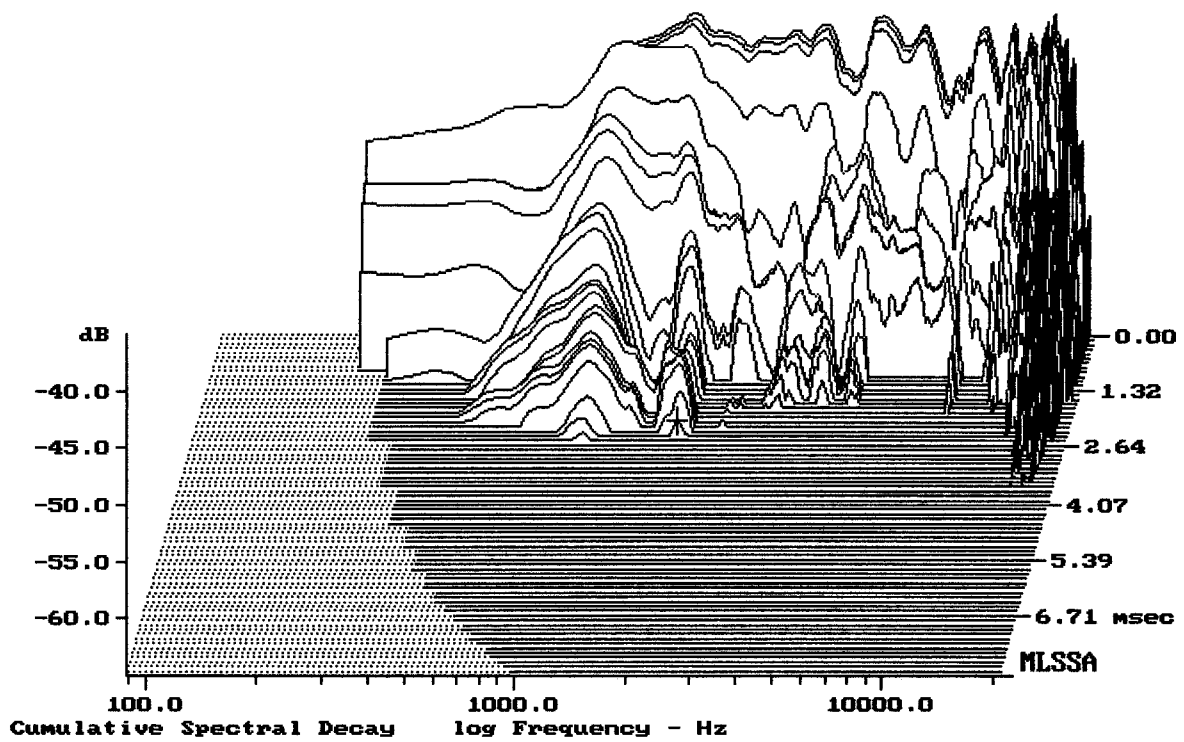

-63.75 dB, 1820 Hz (41), 2.420 msec (23)

Varianta I.

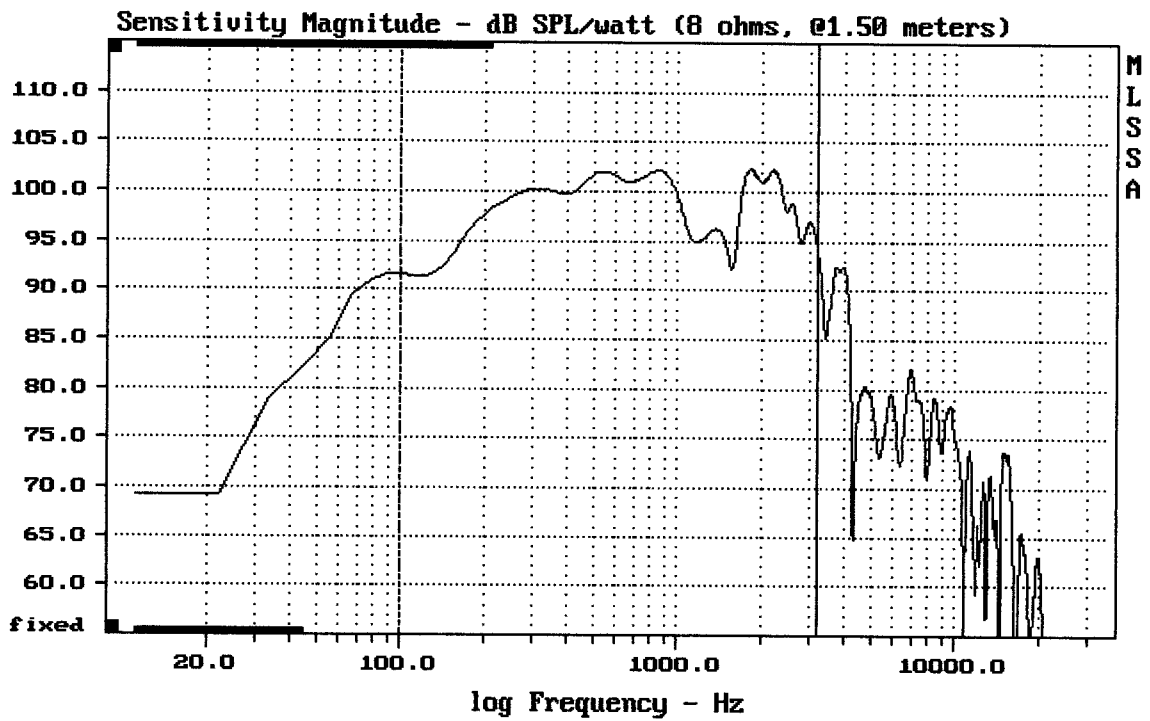



---

Level (100:3196 Hz) = 99.18 dB SPL/watt (8 ohms, @1.50 meters)

---

CX15N351

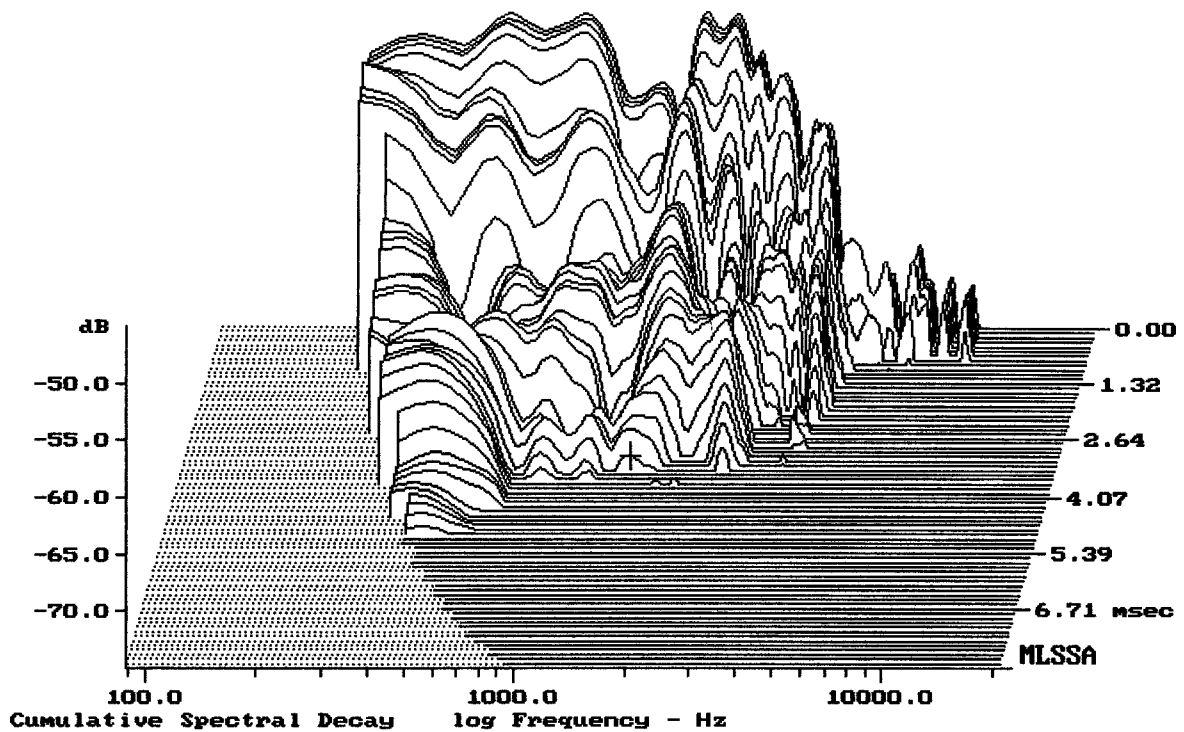
MLSSA: Frequency Domain



-73.80 dB, 1465 Hz (33), 3.410 msec (32)

Varianta I.

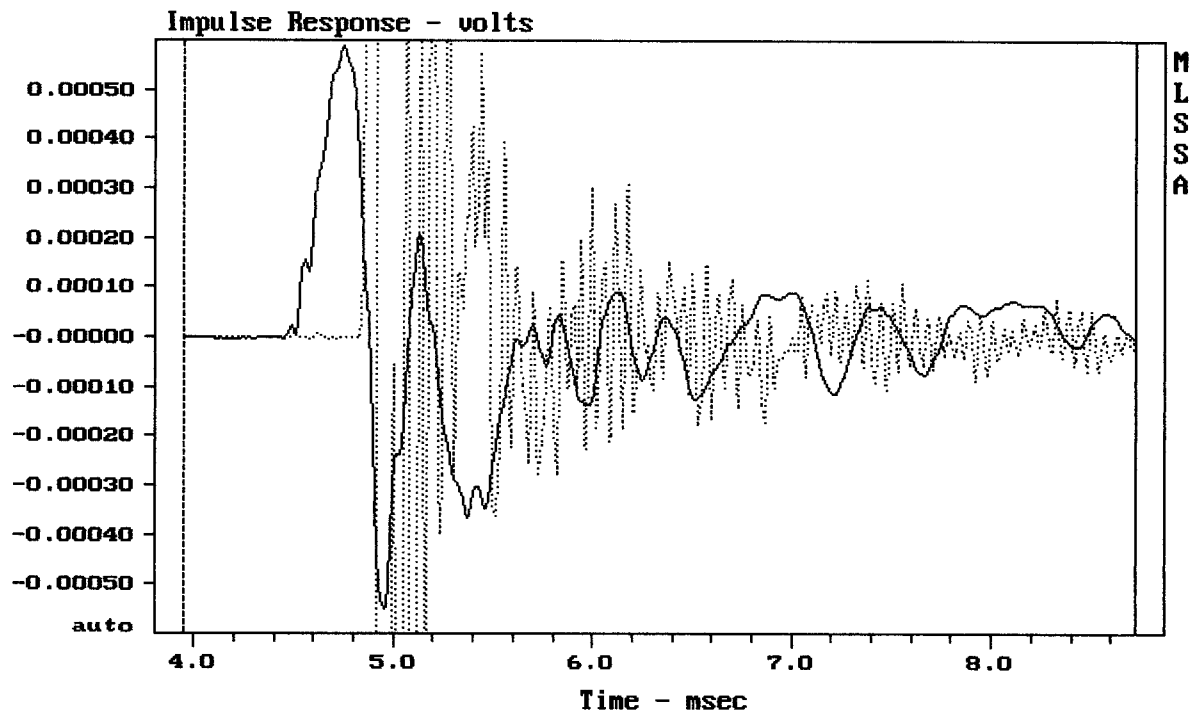

CURSOR: dy = 1.05116e-005 x = 8.7230 (793)

CX15N351

MLSSA: Time Domain

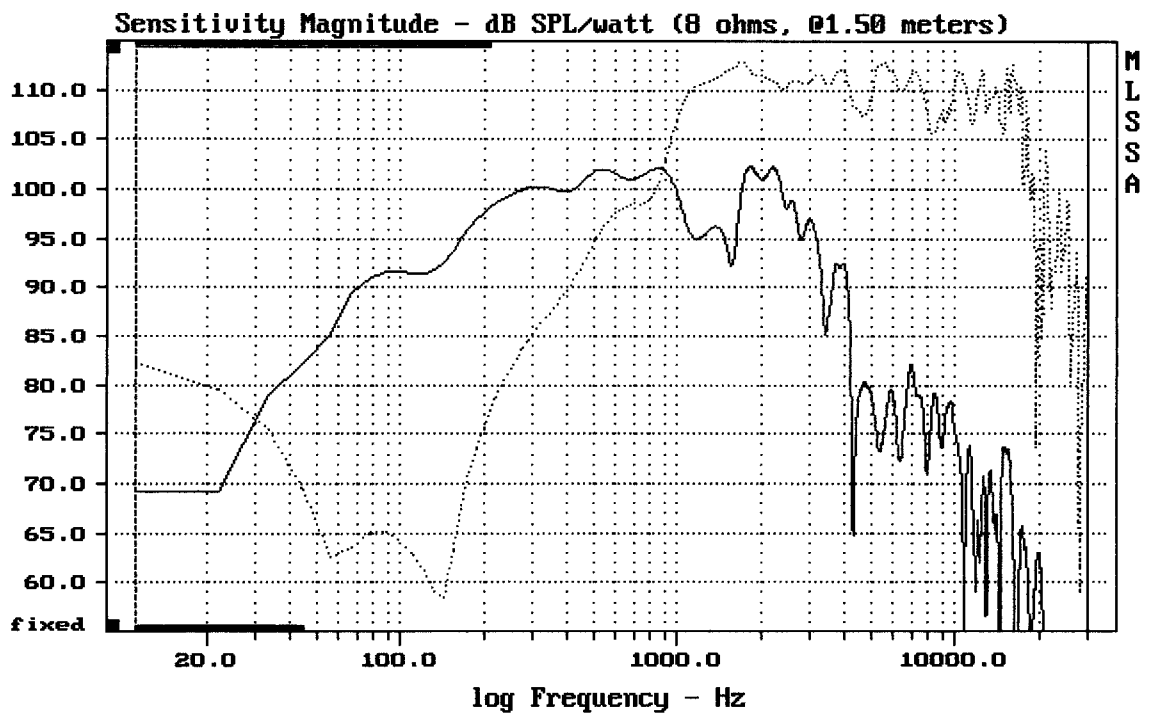

CURSOR: dy = 51.9877 x = 30007.1014 (2704)

CX15N351

Varianta I.

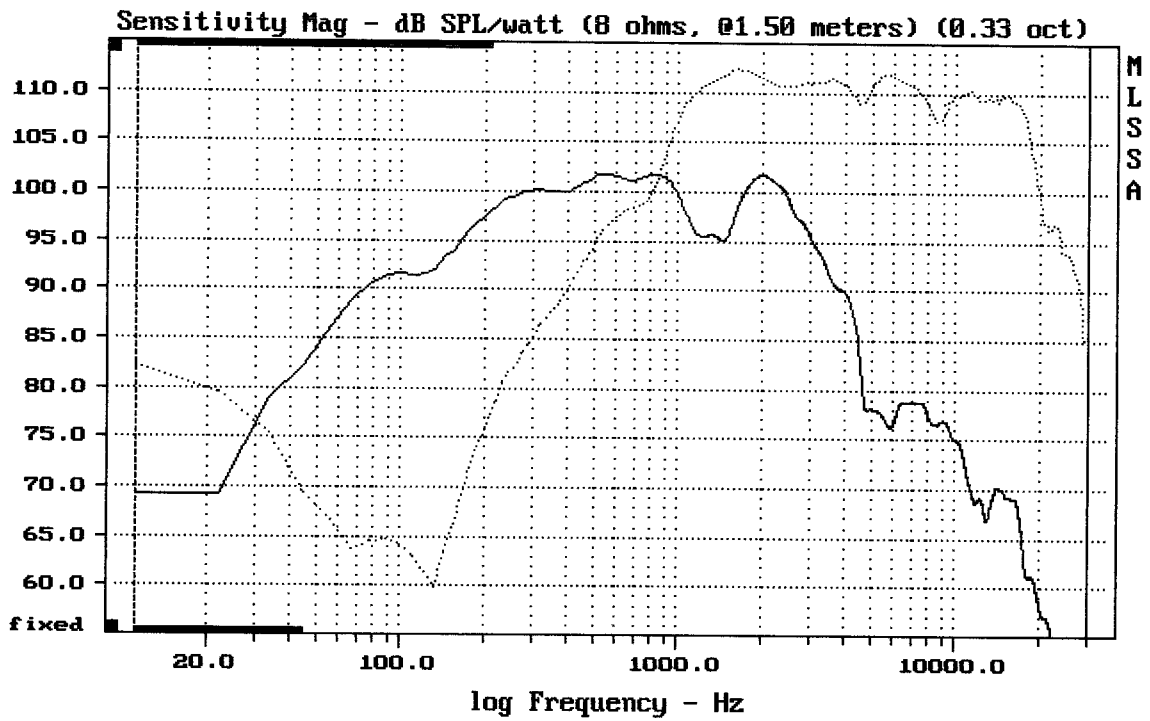

CX15N351

MLSSA: Frequency Domain

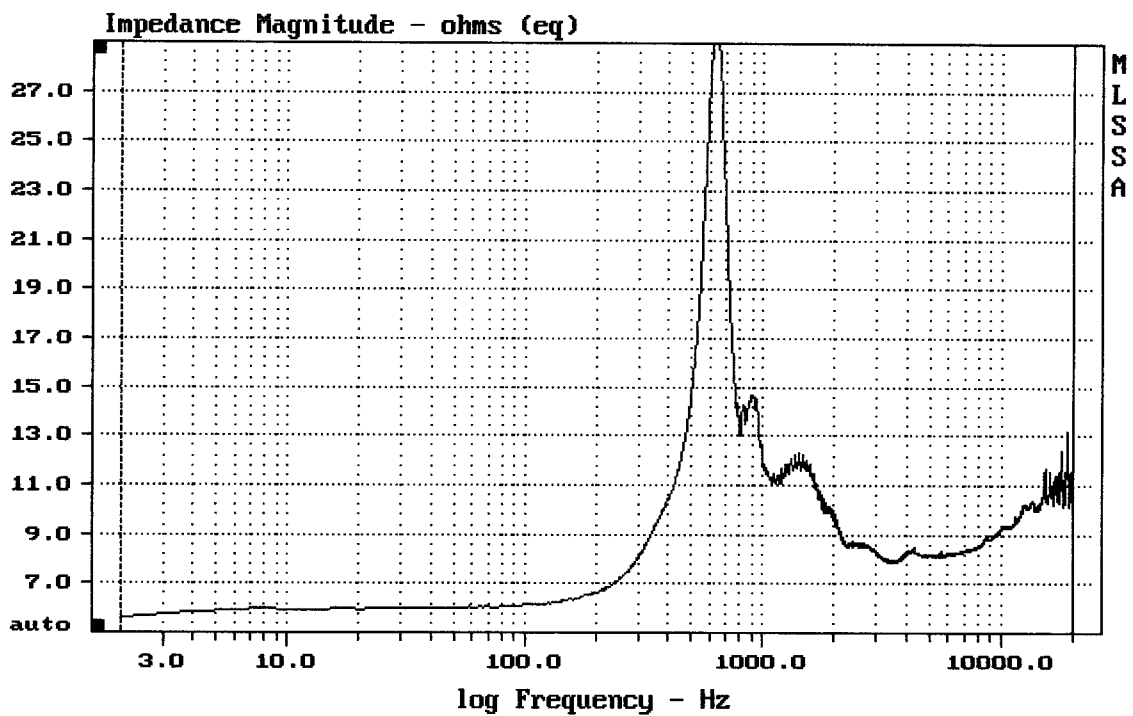

CX15N351

Varianta I.

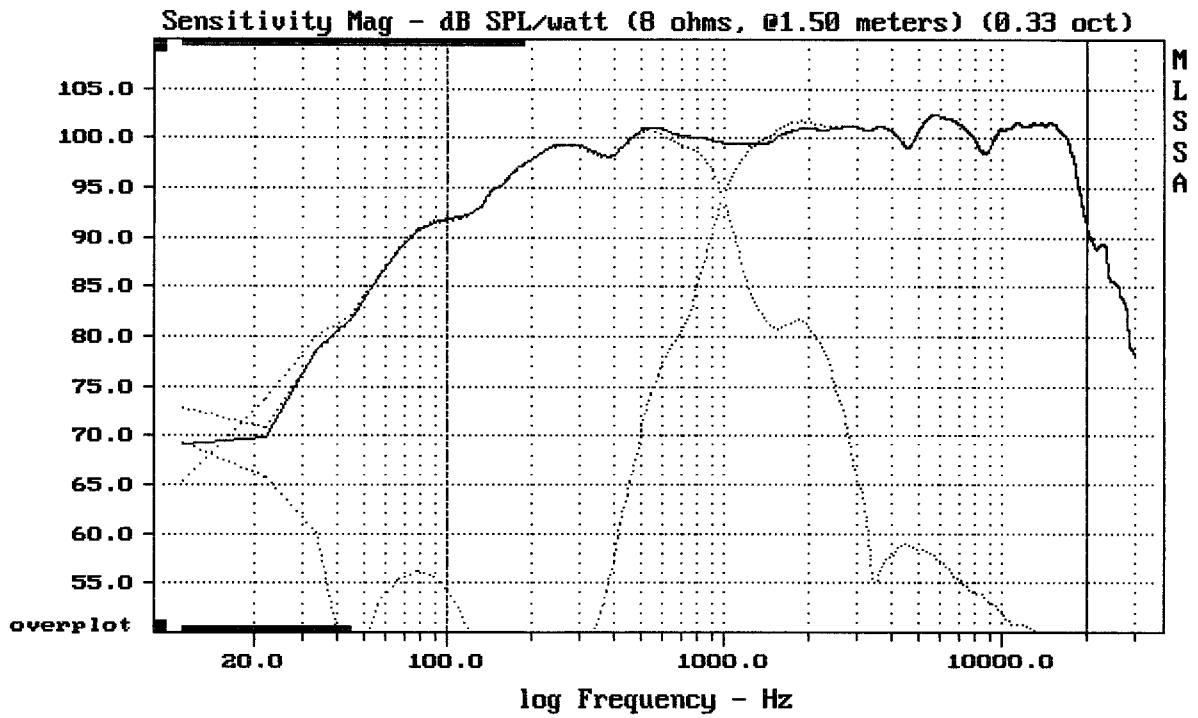



---

Level (100:19997 Hz) = 99.87 dB SPL/watt (8 ohms, @1.50 meters) (0.33 oct)

---

CX15N351

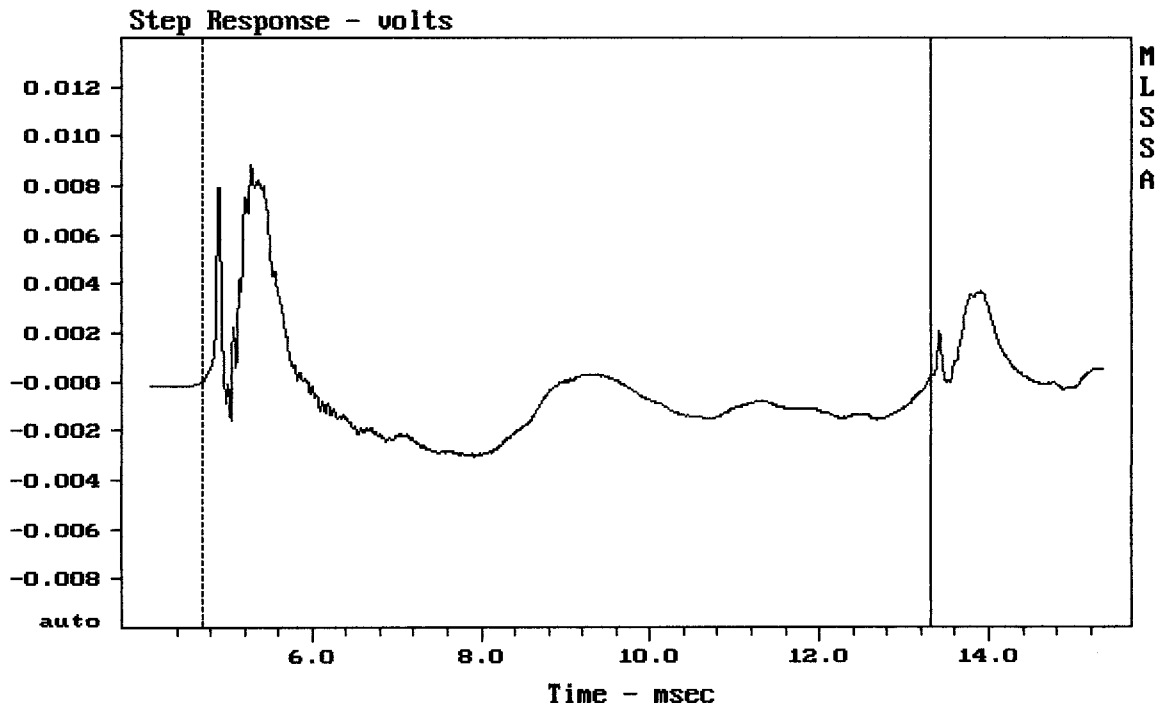
MLSSA: Frequency Domain





---

mean: -0.0006775, rms: 0.00227, std: 0.002167, max: 0.008875, min: -0.003041

---

CX15N351

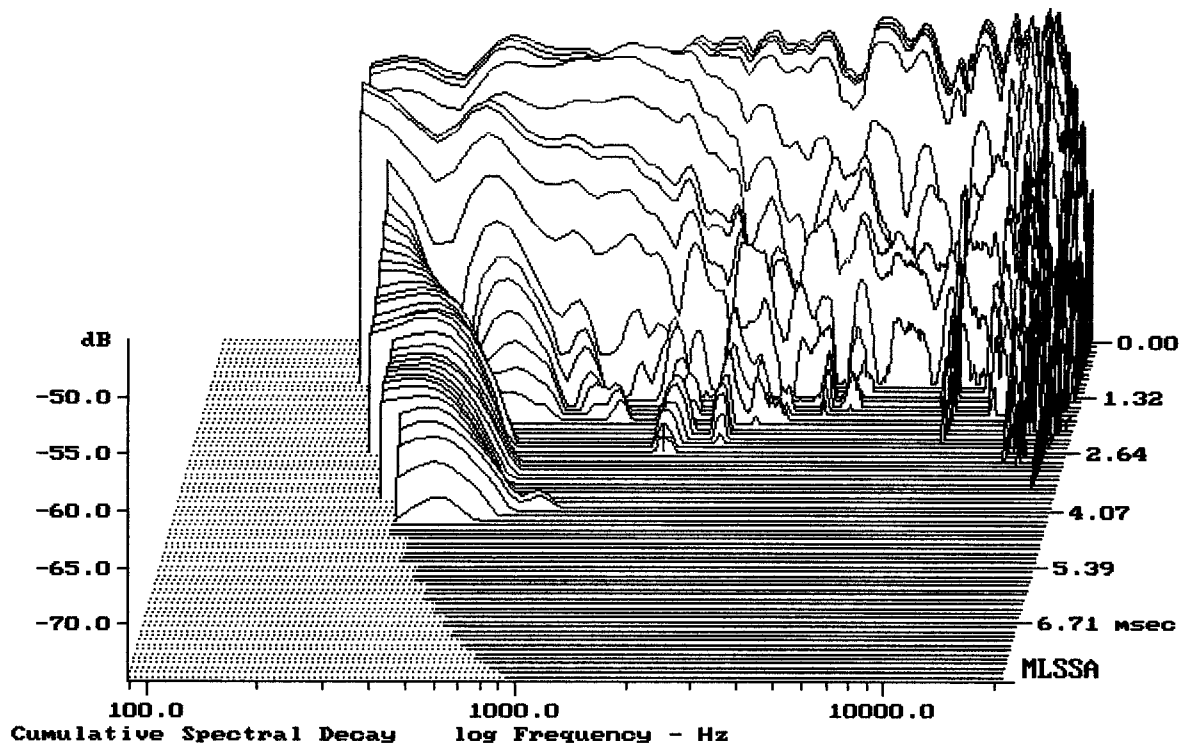
Varianta I.



-73.65 dB, 1687 Hz (38), 2.640 msec (25)

DTTO

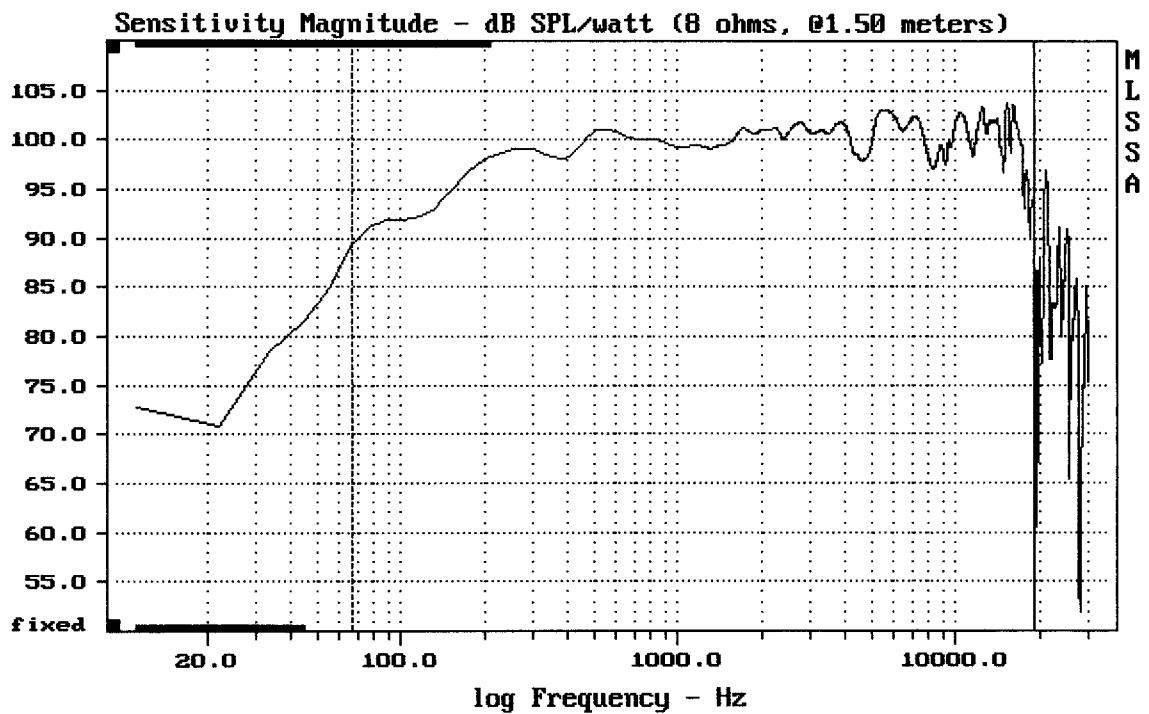

Level (67:19309 Hz) = 99.56 dB SPL/watt (8 ohms, @1.50 meters)

CX15N351

Varianta I.

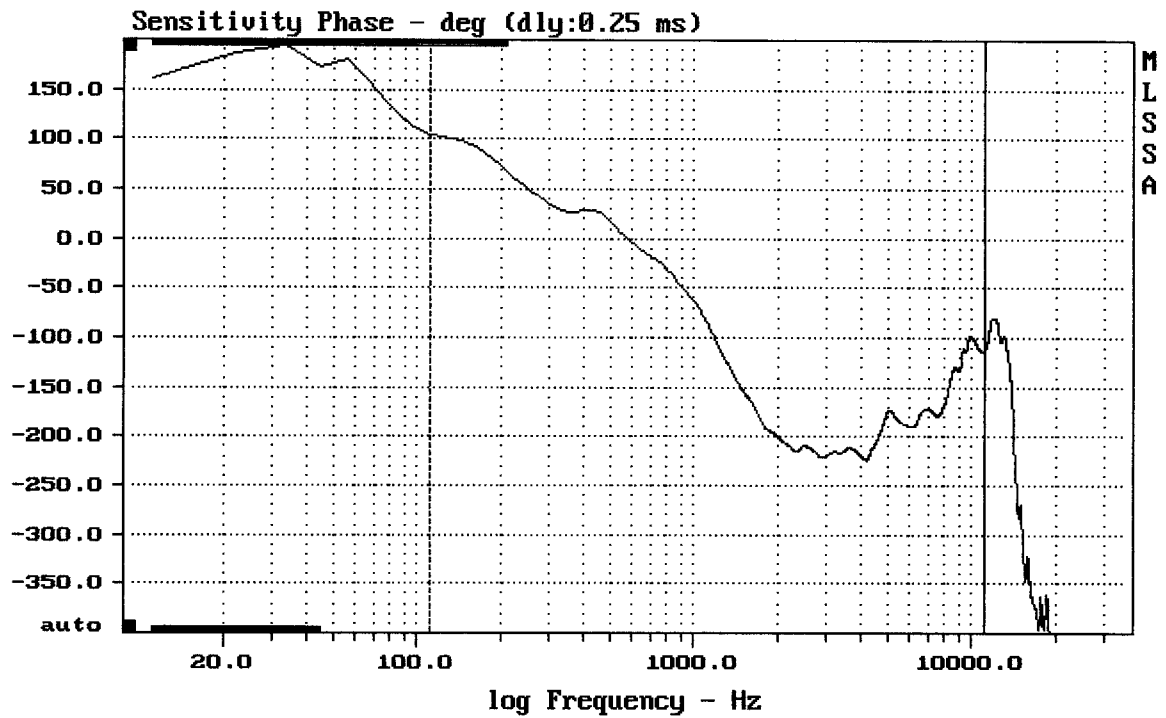

mean: -152.7, rms: 165.1, std: 62.77, max: 104.8, min: -223.8

CX15N351

MLSSA: Frequency Domain

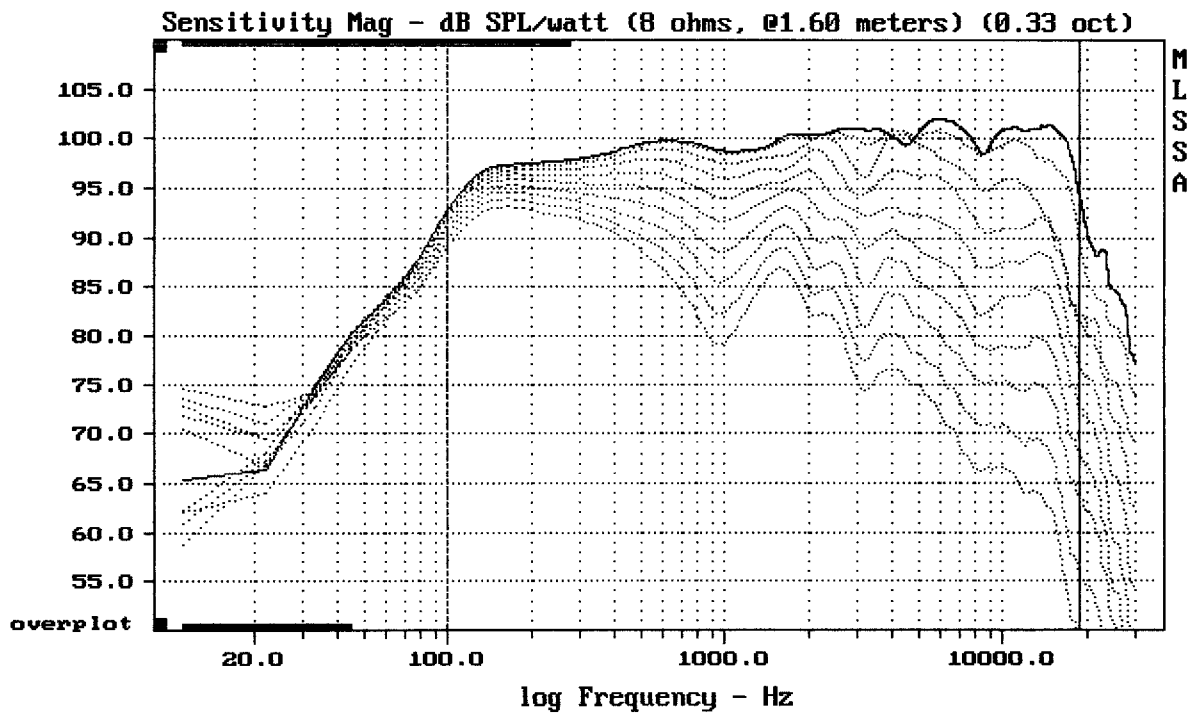

Overlay Compare: dev= +29/-15, std= 9.4, avg= -33

CX15N351

Varianta I.



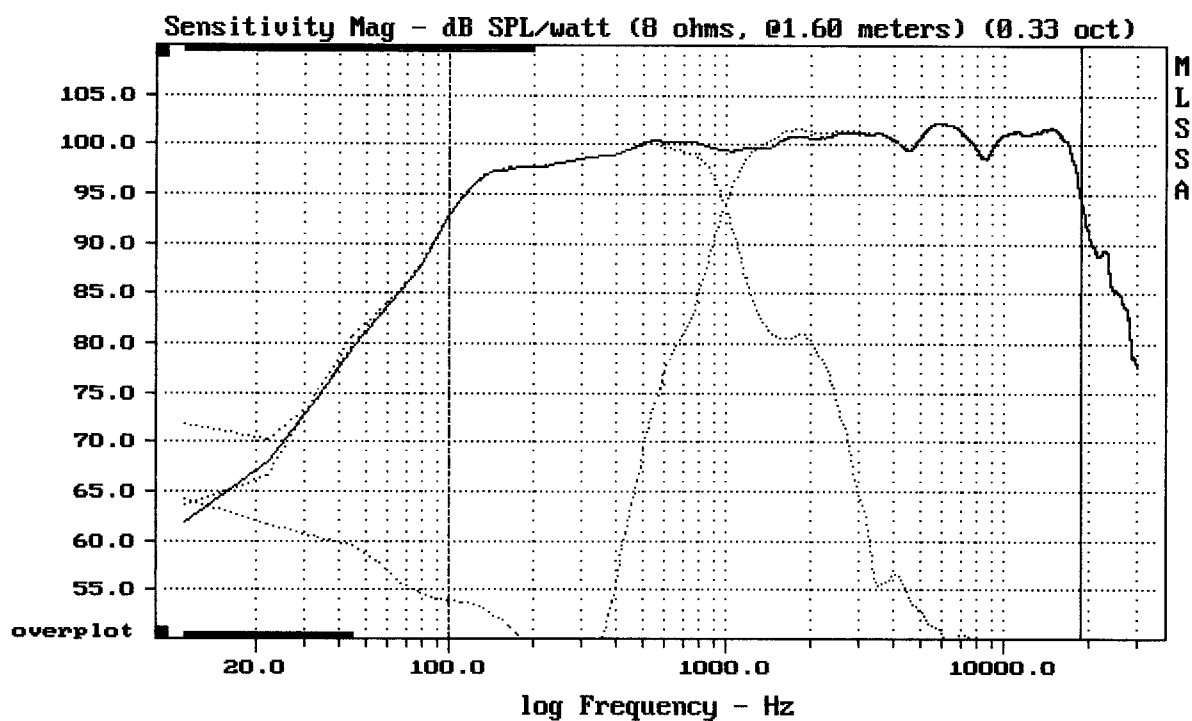



---

Level (100:19010 Hz) = 99.89 dB SPL/watt (8 ohms, @1.60 meters) (0.33 oct)

---

CX15N351

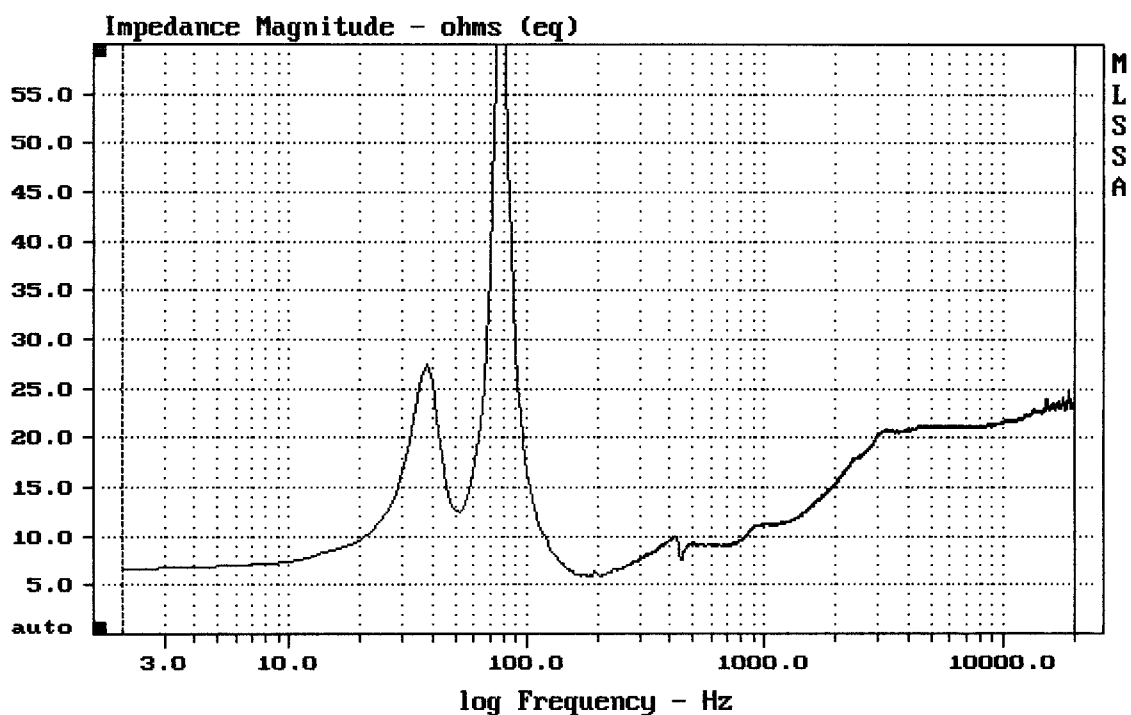
MLSSA: Frequency Domain





---

mean: 20.83, rms: 21.16, std: 3.728, max: 75.82, min: 5.865

---

CX15N351

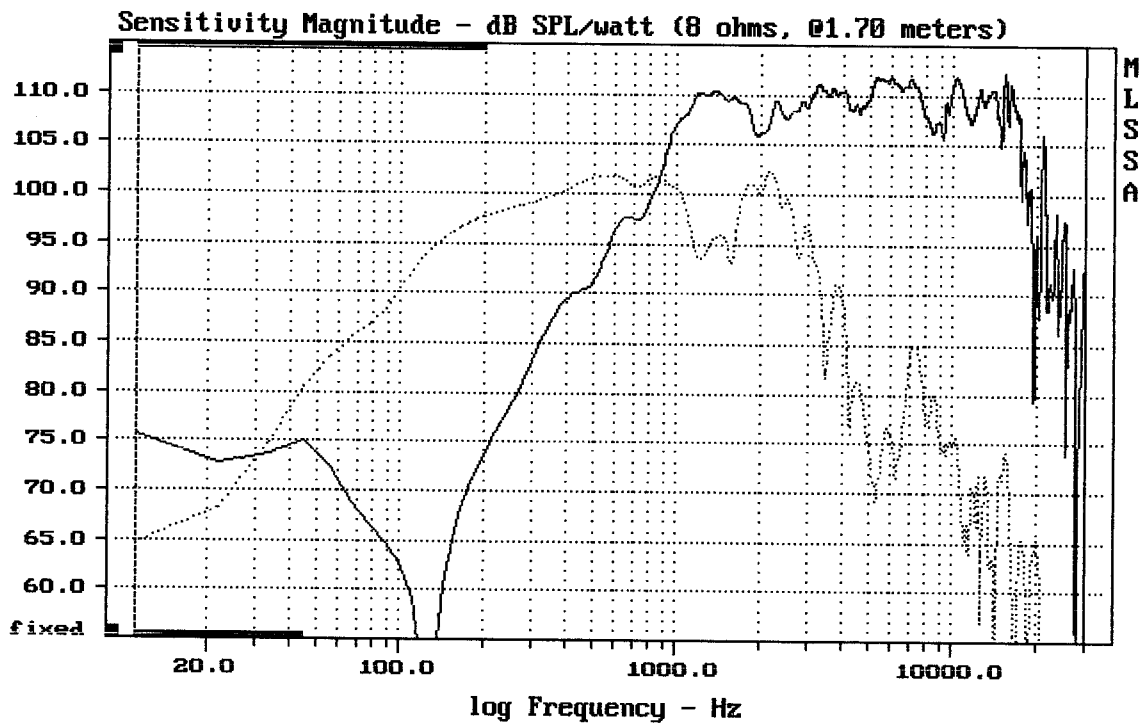
Varianta I.



CURSOR:  $dy = -45.0114$   $x = 30007.1014$  (2704)

CX15N351

MLSSA: Frequency Domain

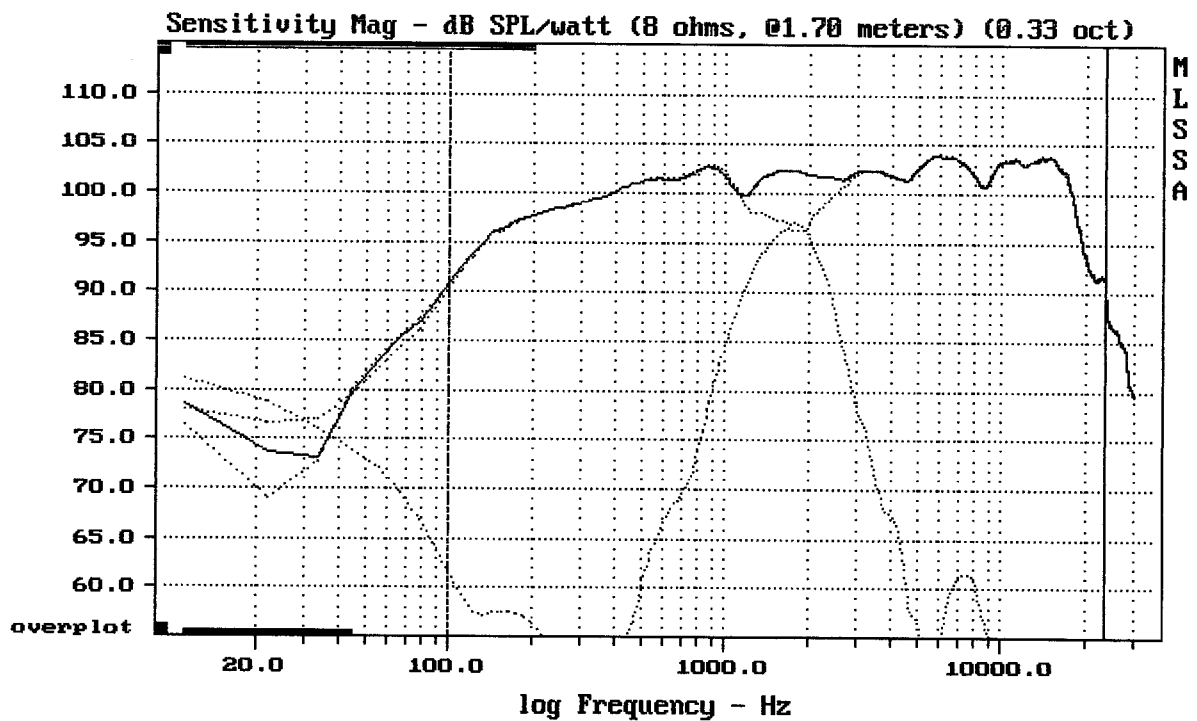

Level (100:23504 Hz) = 101.14 dB SPL/watt (8 ohms, @1.70 meters) (0.33 oct)

CX15N351

Varianta II.

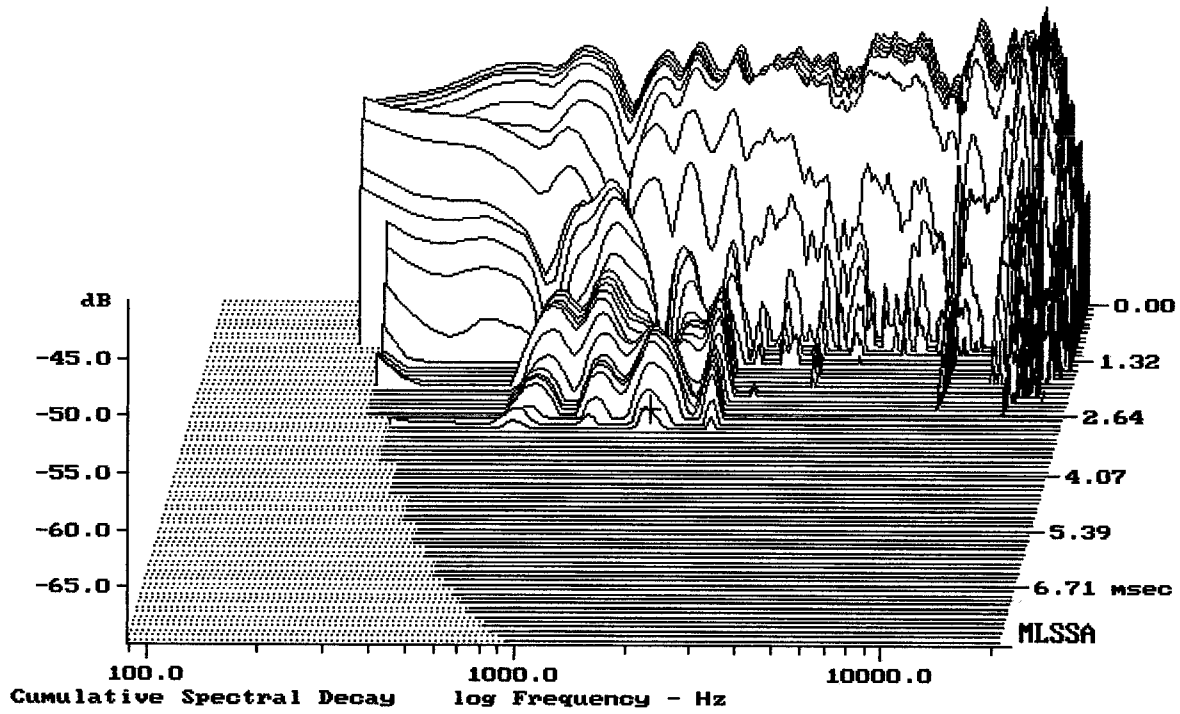

-68.27 dB, 1598 Hz (36), 2.970 msec (28)

DTTO

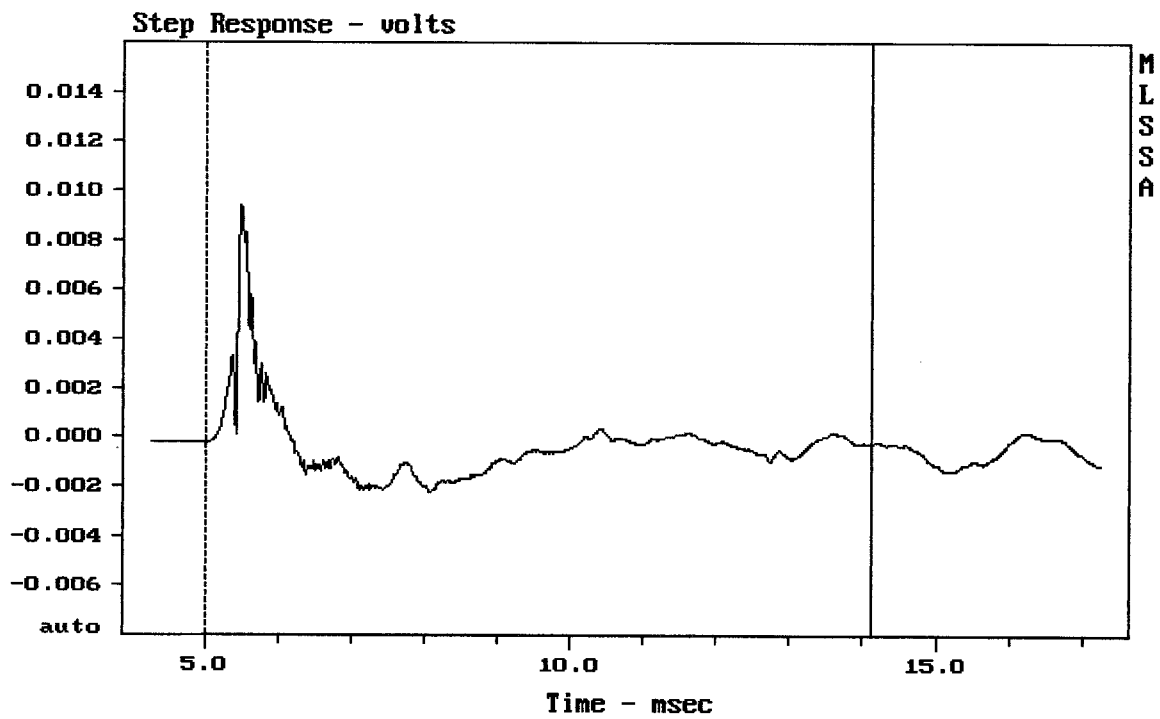

mean: -0.0003632, rms: 0.001556, std: 0.001513, max: 0.009349, min: -0.00223

CX15N351

Varianta II.

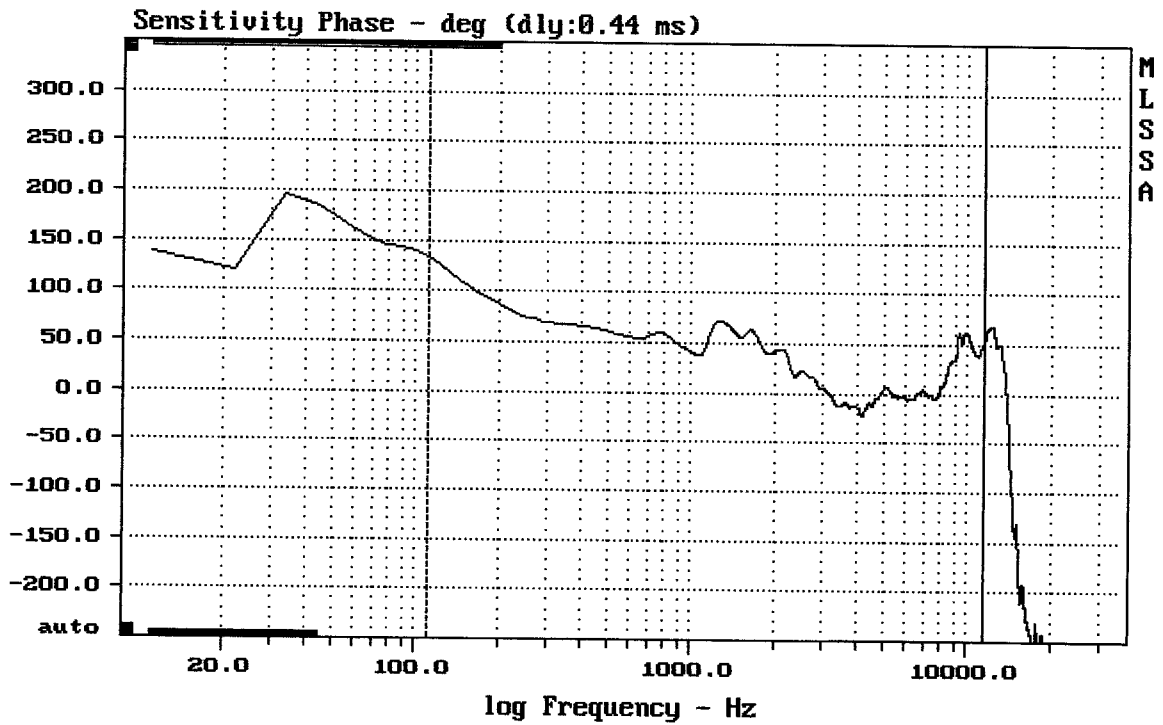

CURSOR: y = 49.7873 x = 11419.1225 (1029)

CX15N351

MLSSA: Frequency Domain

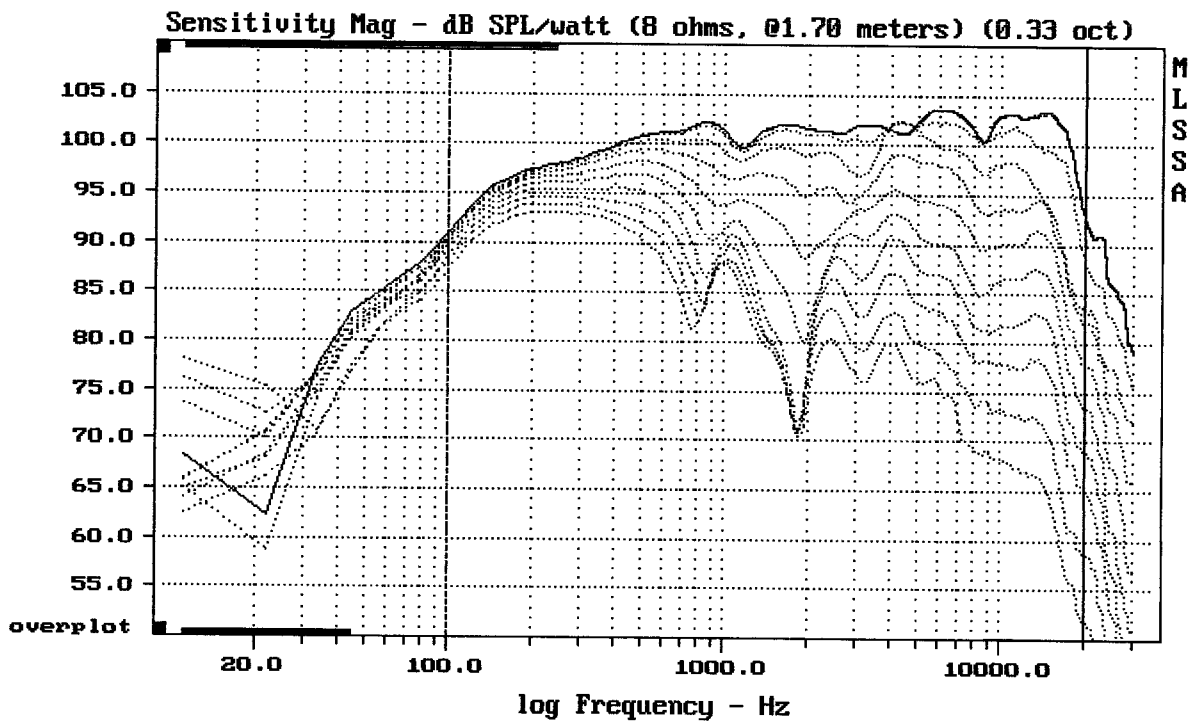

Overlay Compare: dev= +29/-12, std= 8.5, avg= -33

CX15N351

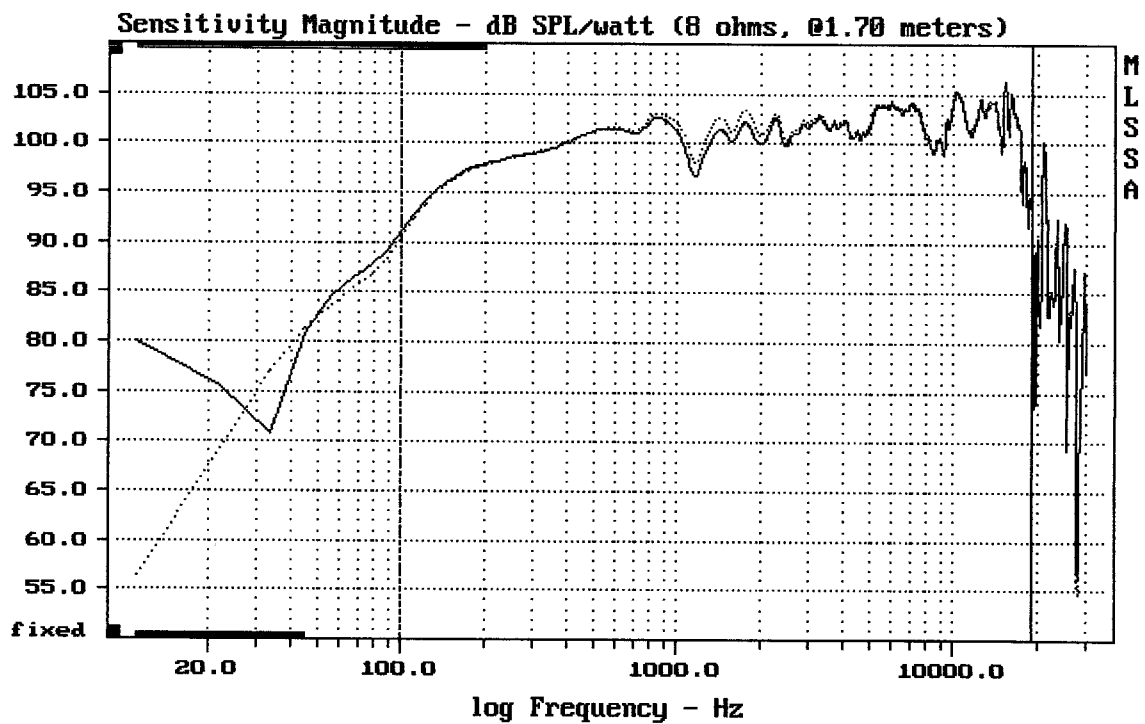

Overlay Compare: dev= +0.86/-1.1, std= 0.24, avg= -0.29

CX15N351

- odpor 1ohm způsobí vzestup impedance kolem 1500Hz MLSSA: Frequency Domain  
a NAOPAK u předchozího grafu pokles citlivosti ve zhruba stejné oblasti

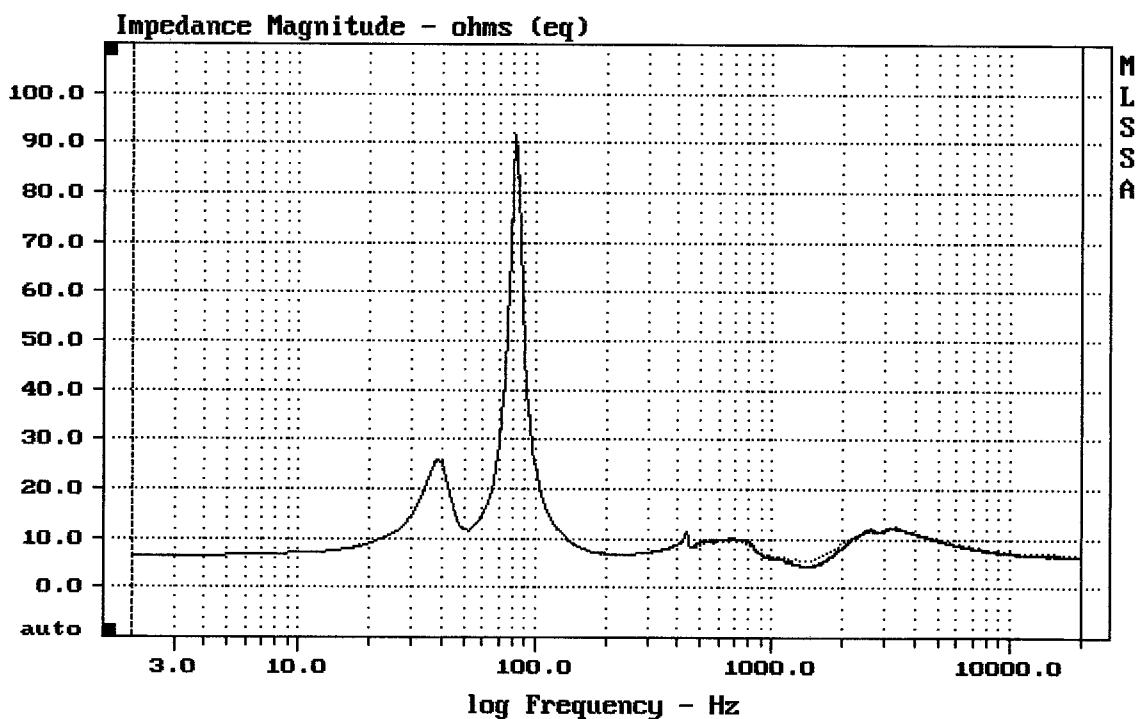

mean: 8.124, rms: 8.519, std: 2.565, max: 90.18, min: 5.538

CX15N351

... s odporem 1R