

Sestava B&C Speakers 10PLB76 + BMS BMS4538 + Megaton A9090m

Osazení:

- B&C Speakers 10PLB76 8/Ohm
<http://eshop.prodance.cz/DetailPage.asp?DPG=82644>
- BMS BMS4538 8/Ohm
<http://eshop.prodance.cz/DetailPage.asp?DPG=87248>
- Megaton A9090m
<http://eshop.prodance.cz/DetailPage.asp?DPG=83921>

Schéma výhybky:

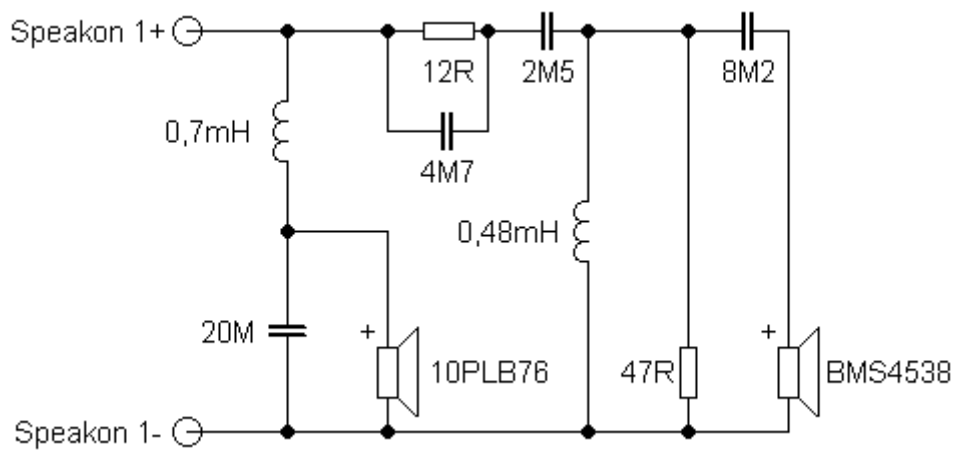

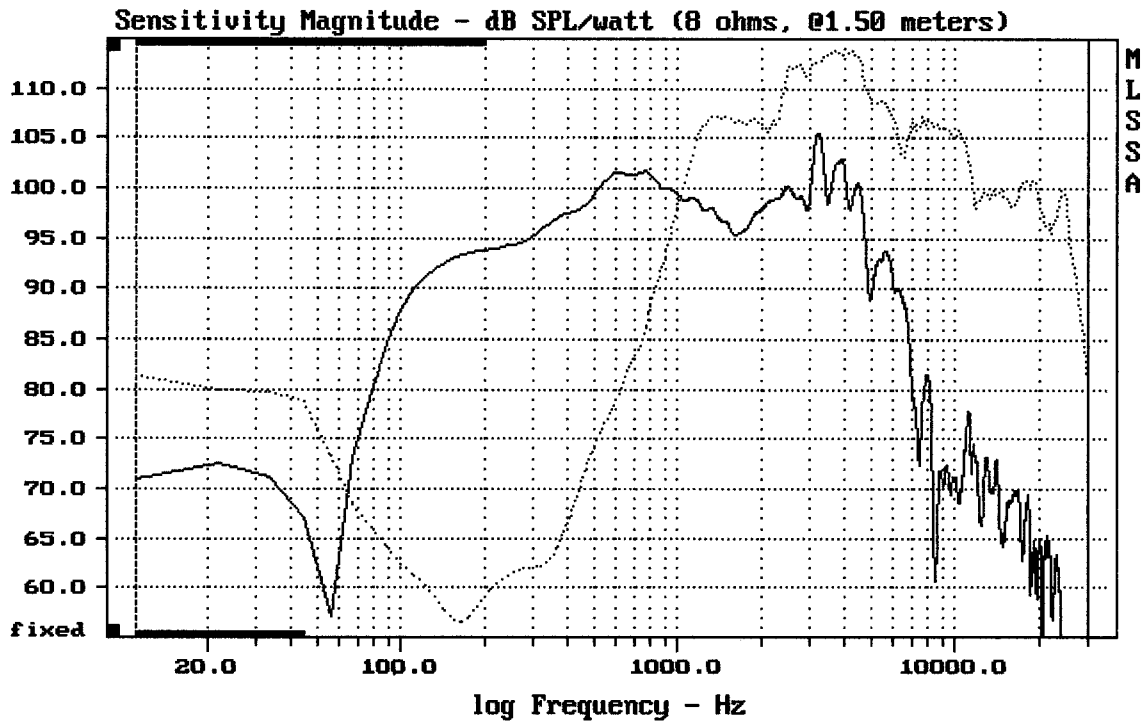

CURSOR: dy = 41.4999 x = 30007.1014 (2704)

10PLB76 + BMS4538 + A9090m

MLSSA: Frequency Domain

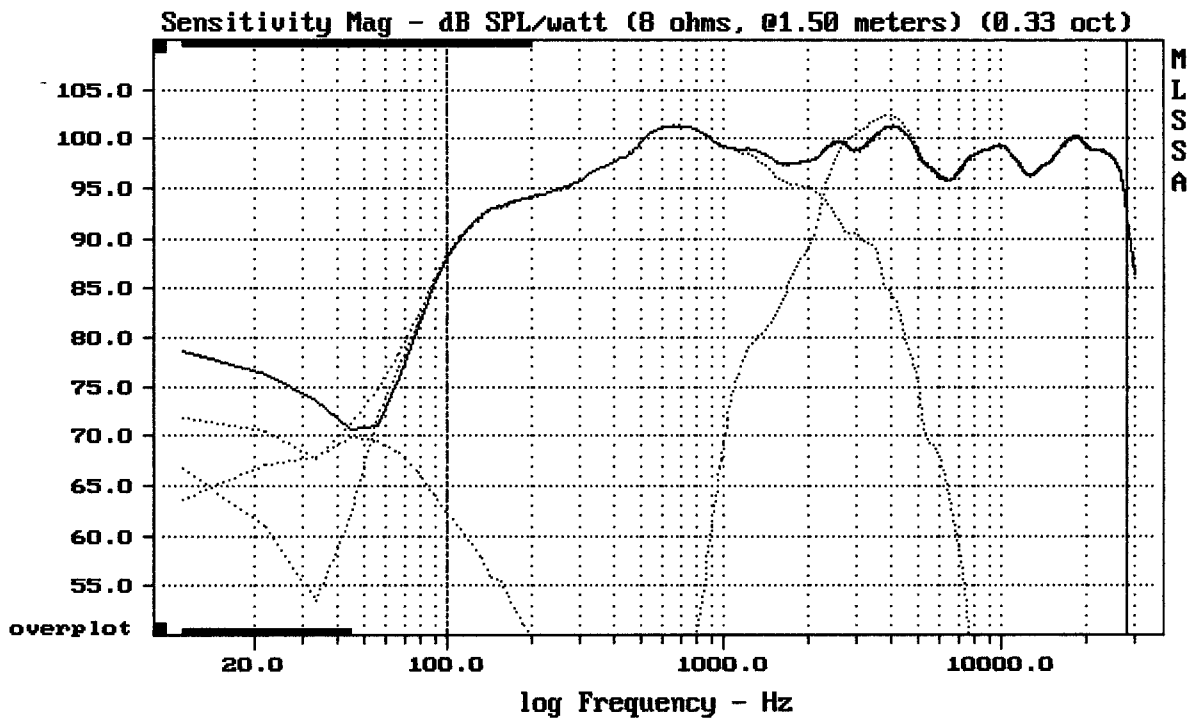

Level (100:20010 Hz) = 98.25 dB SPL/watt (8 ohms, @1.50 meters) (0.33 oct)

10PLB76 + BMS4538 + A9090m

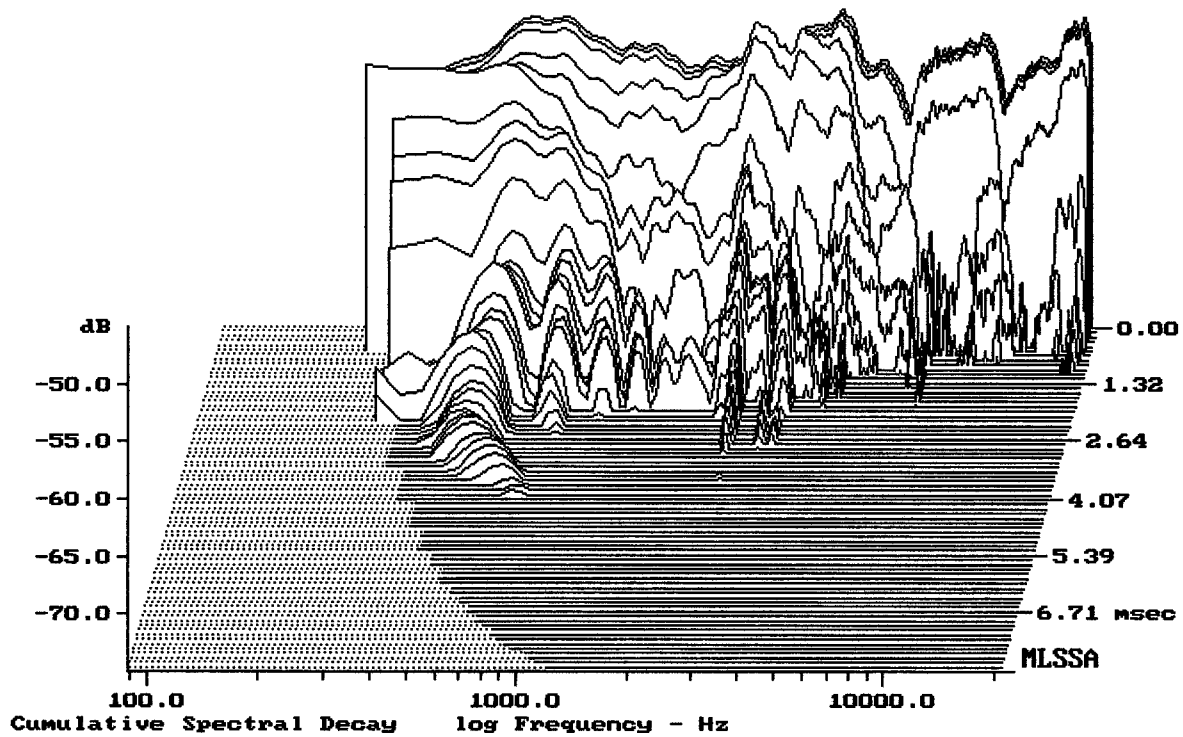

-73.71 dB, 2486 Hz (56), 2.860 msec (27)

DTTO

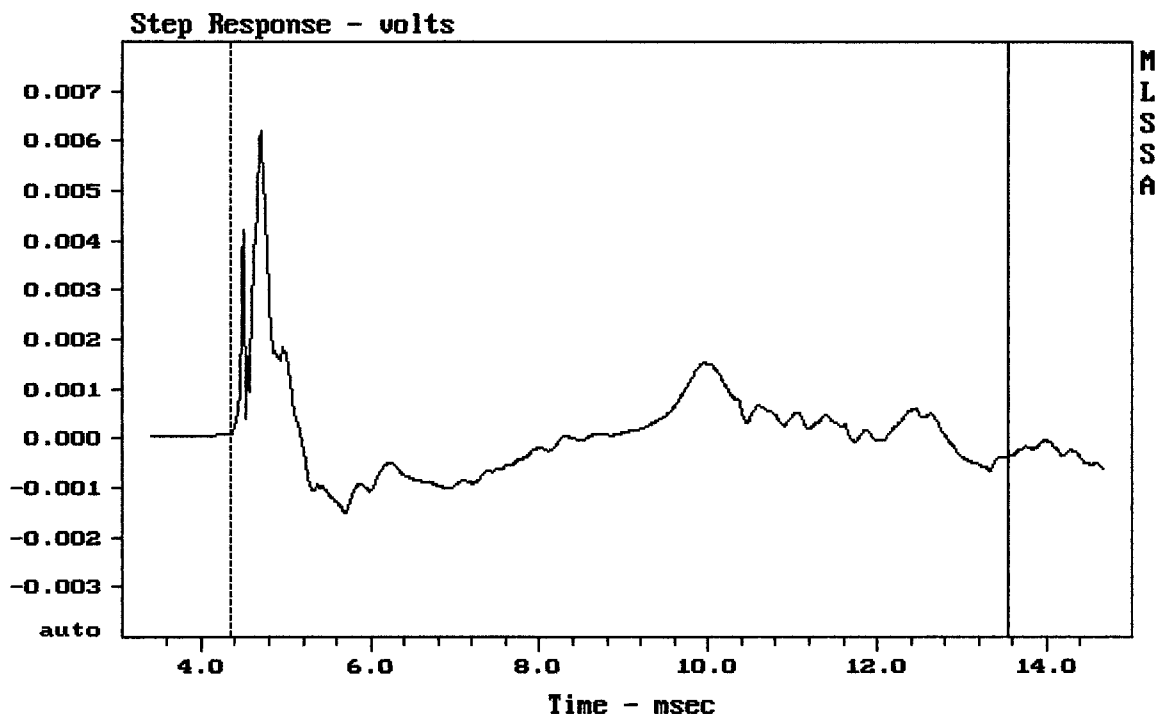

mean: 0.0001147, rms: 0.001034, std: 0.001027, max: 0.006204, min: -0.001498

10PLB76 + BMS4538 + A9090m

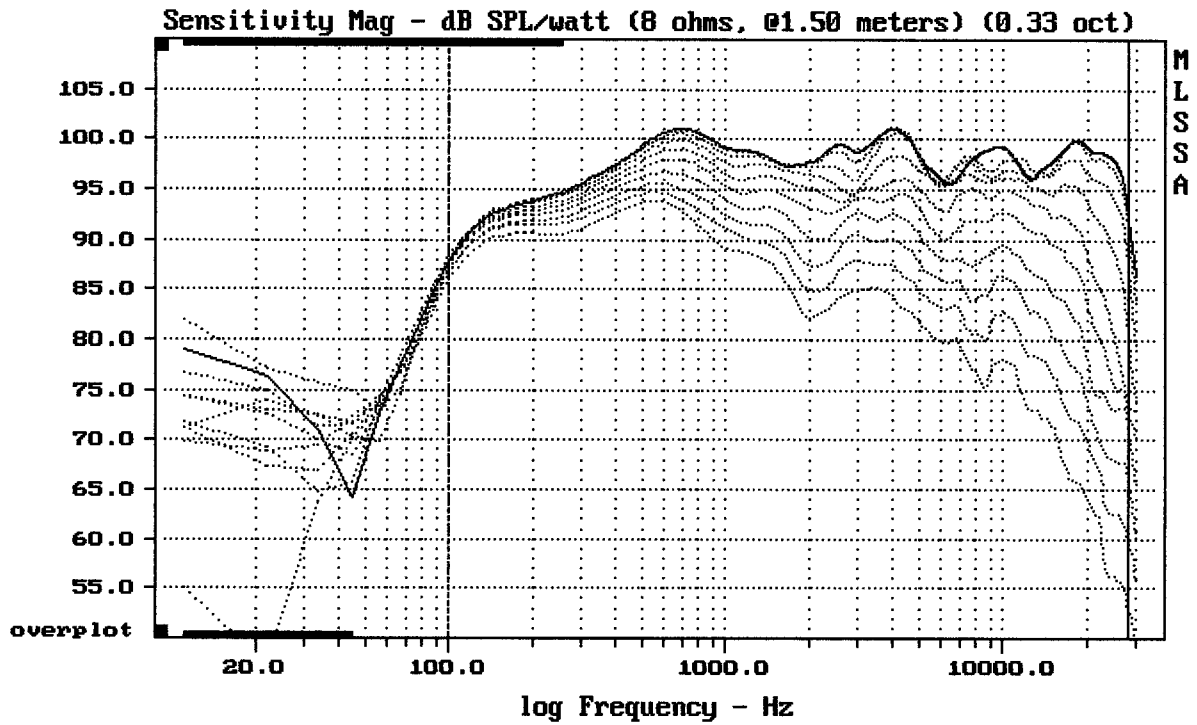

Overlay Compare: dev= +25/-15, std= 10, avg= -27

10PLB76 + BMS4538 + A9090m

MLSSA: Frequency Domain

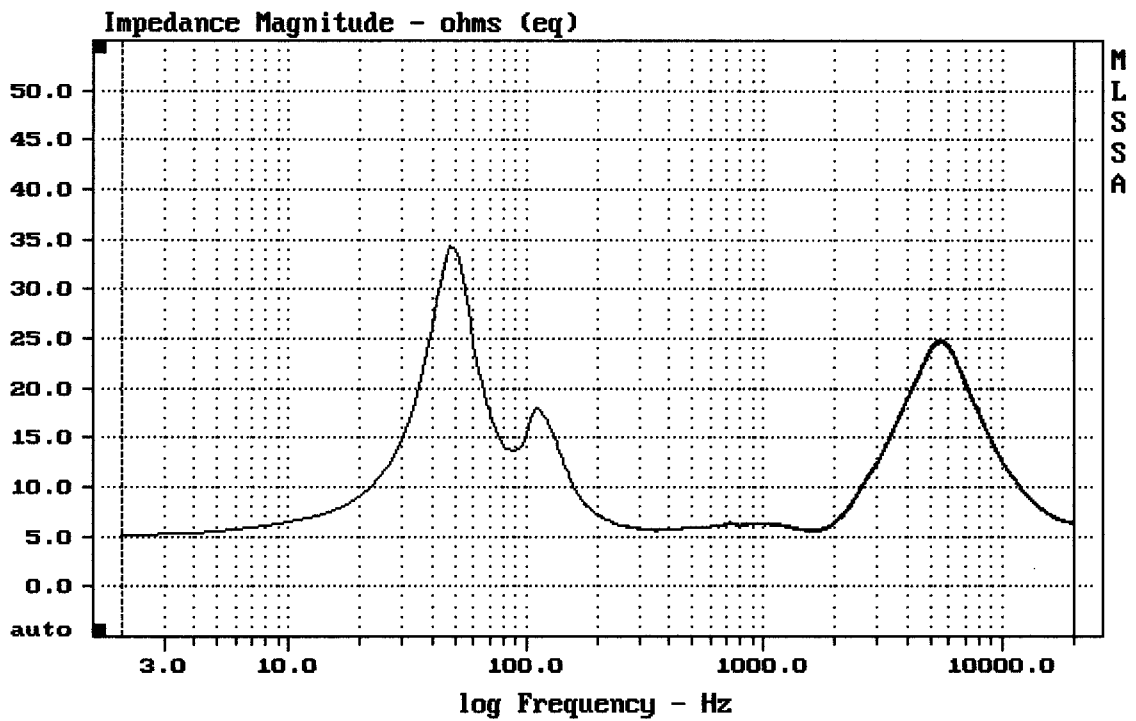

mean: 11.89, rms: 13.29, std: 5.932, max: 34.31, min: 5.084

10PLB76 + BMS4538 + A9090m