

## Sestava Eminence Beta-10 + B&C Speakers DE10 + Megaton A8080

### Osazení:

- Eminence Beta-10 8/Ohm

<http://eshop.prodance.cz/DetailPage.asp?DPG=84338>

- B&C Speakers DE10 8/Ohm

<http://eshop.prodance.cz/DetailPage.asp?DPG=82290>

- Megaton A8080

<http://eshop.prodance.cz/DetailPage.asp?DPG=83916>

### Schéma výhybky:

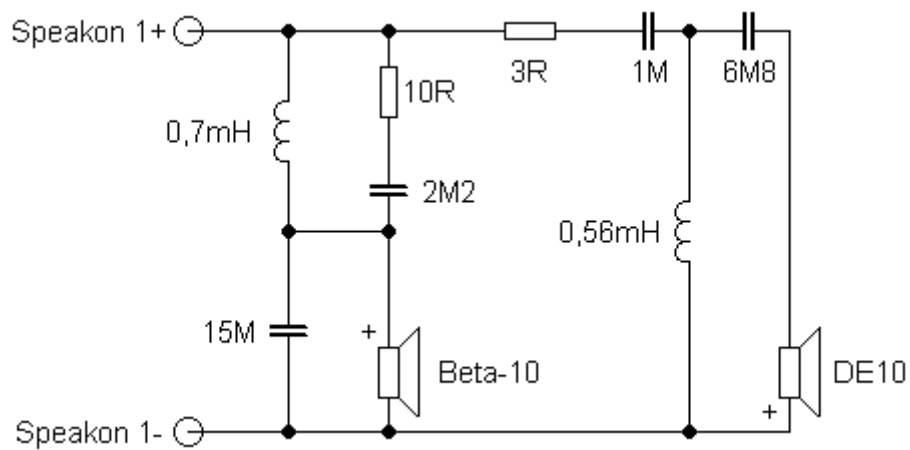

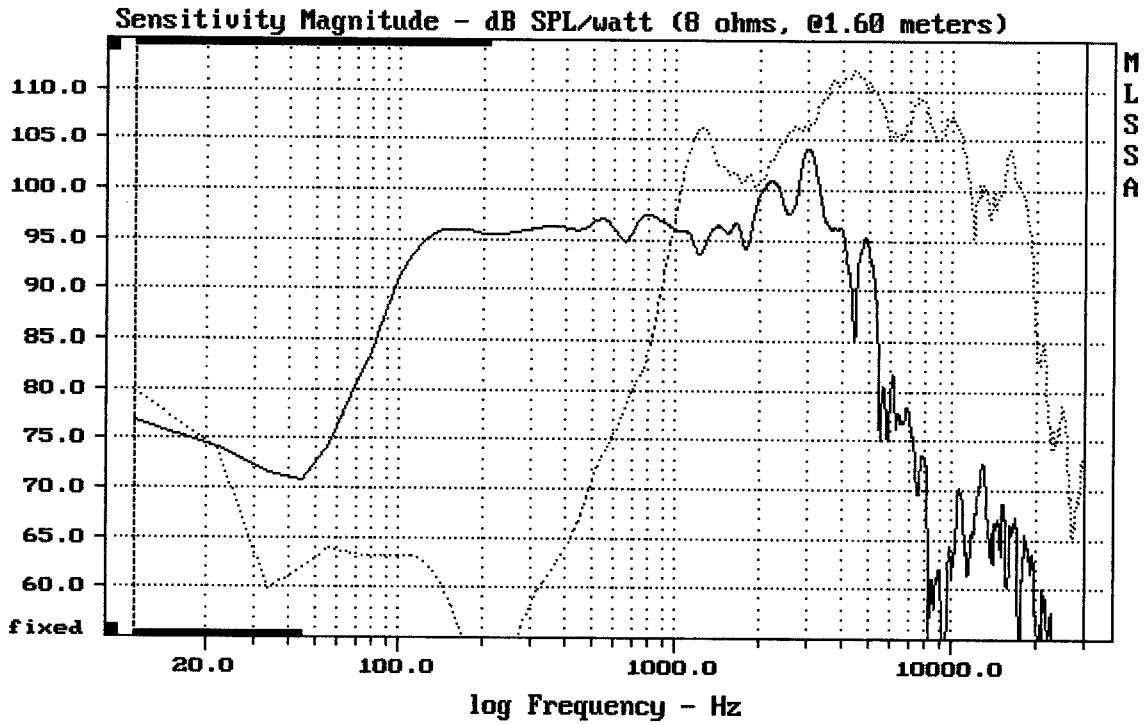

CURSOR: dy = 32.5318 x = 30007.1014 (2704)

BETA 10 + DE10 + A8080

MLSSA: Frequency Domain

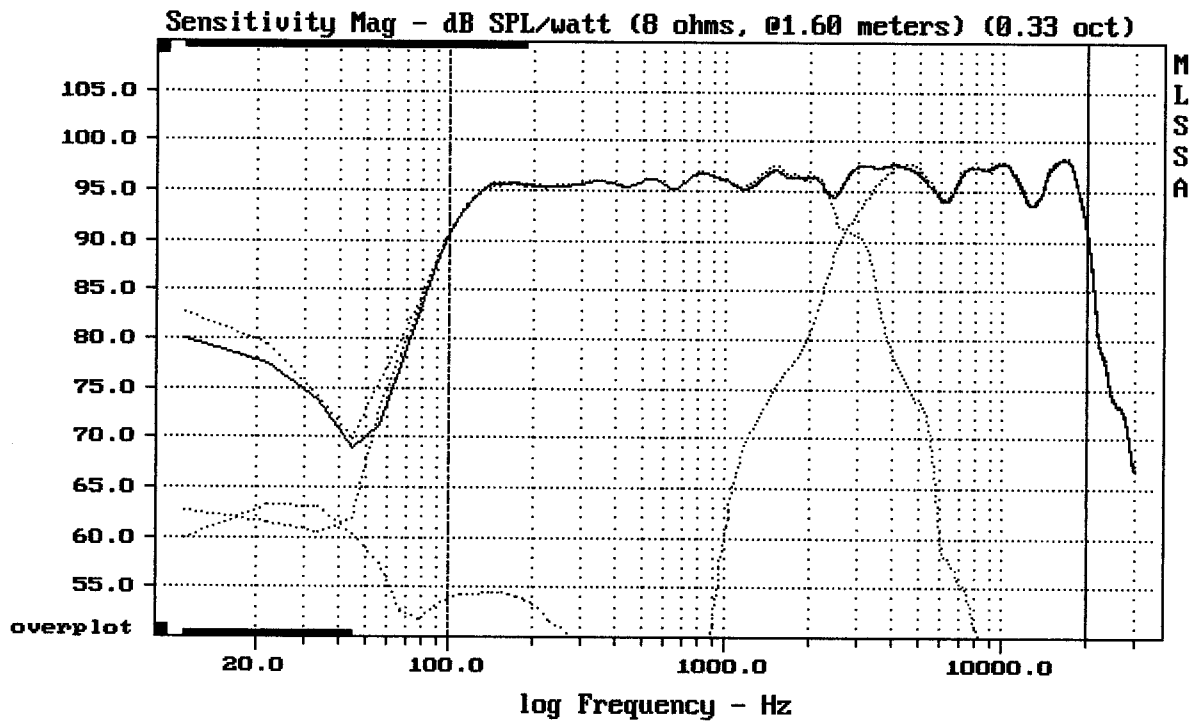

Level (100:1997 Hz) = 96.07 dB SPL/watt (8 ohms, @1.60 meters) (0.33 oct)

BETA 10 + DE10 + A8080

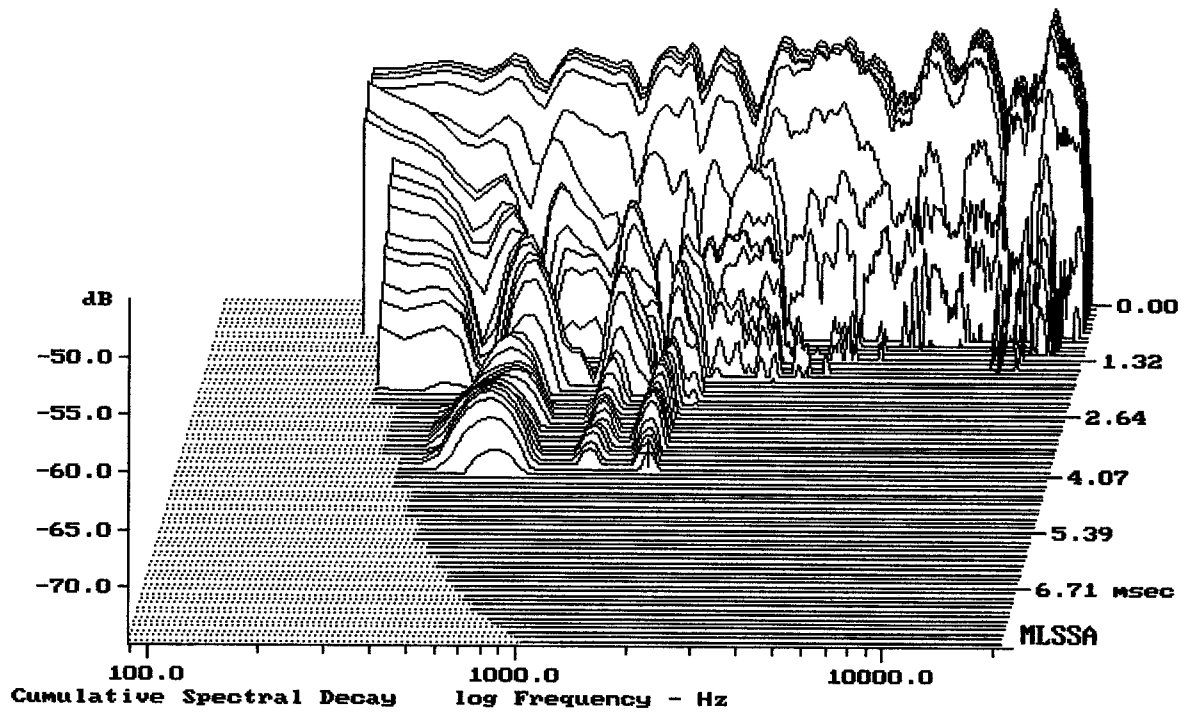

-73.47 dB, 1687 Hz (38), 3.960 msec (37)

DITO

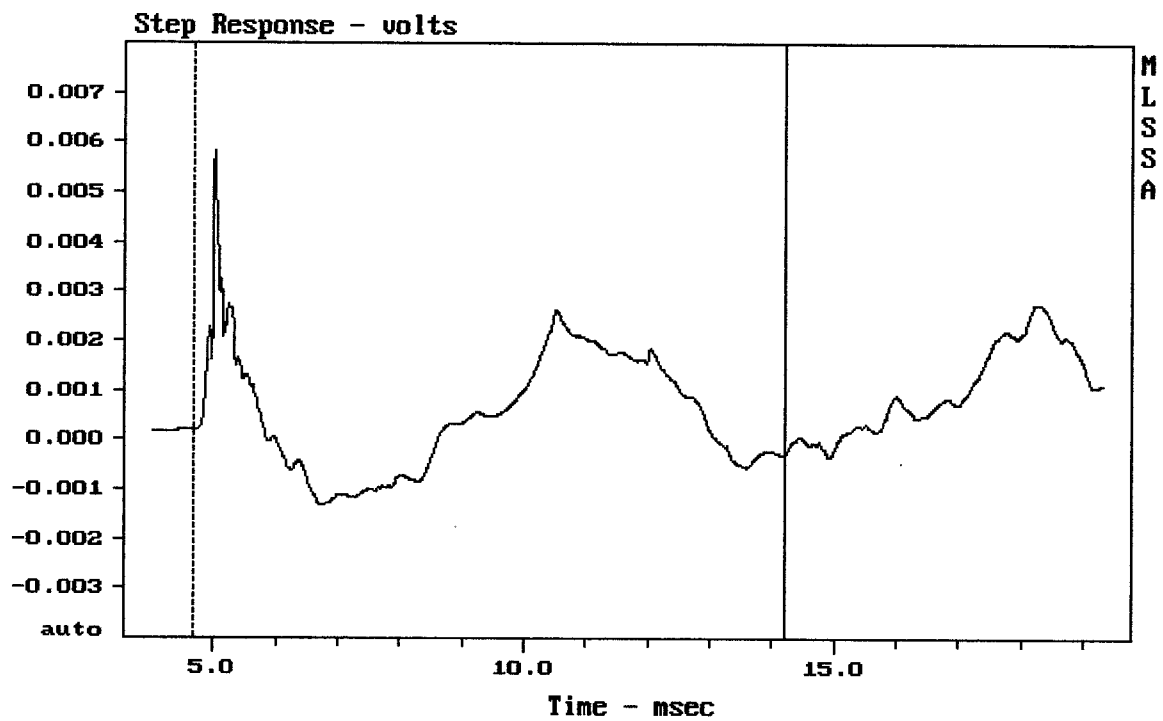

mean: 0.0005101, rms: 0.001307, std: 0.001203, max: 0.0058, min: -0.001326

BETA 10 + DE10 + A8080

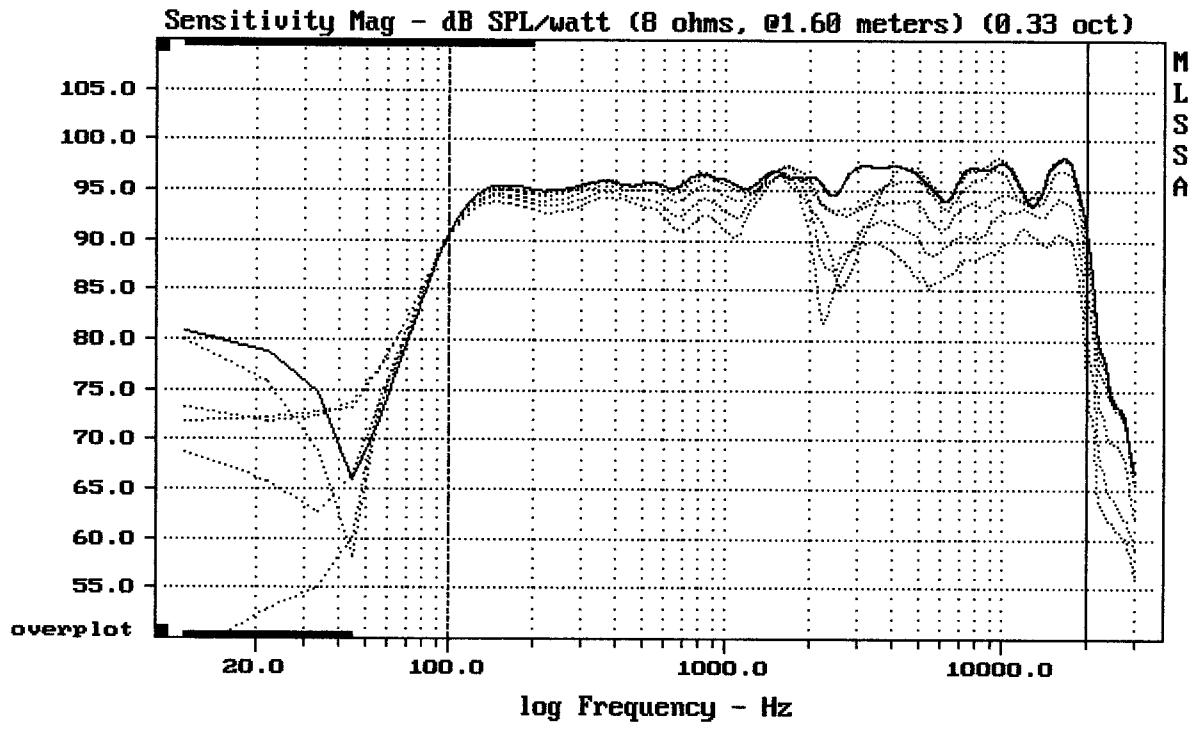



---

Overlay Compare: dev= +7.4/-7.6, std= 2.6, avg= -7.2

---

BETA 10 + DE10 + A8080

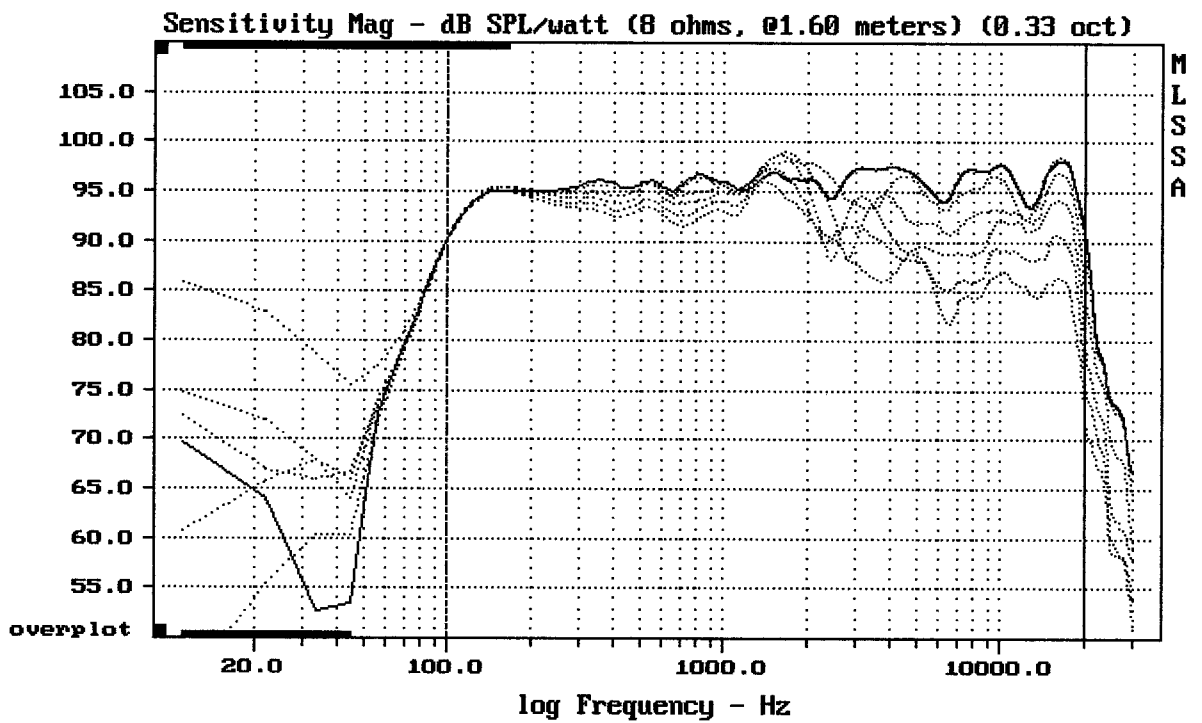
MLSSA: Frequency Domain





---

Overlay Compare: dev= +10/-7.6, std= 3.4, avg= -10

---

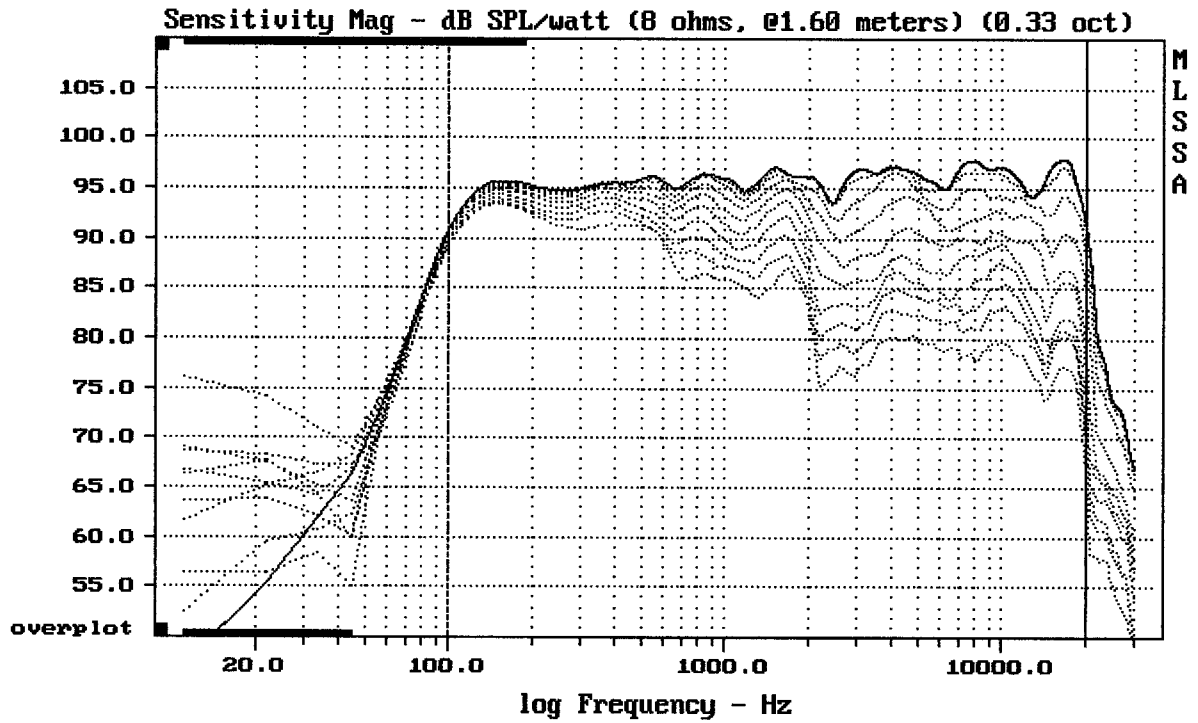
BETA 10 + DE10 + A8080





---

Overlay Compare: dev= +16/-6.5, std= 3.7, avg= -18

---

BETA 10 + DE10 + A8080

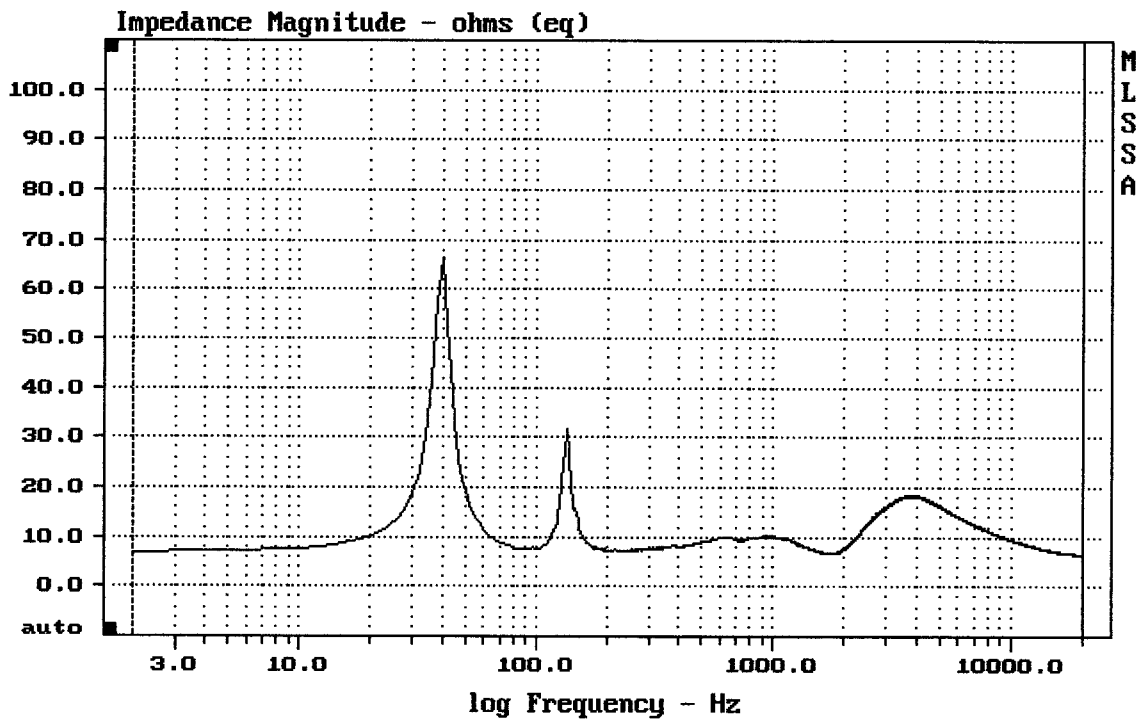
MLSSA: Frequency Domain



---

mean: 10.01, rms: 10.67, std: 3.705, max: 66.17, min: 6.335

---

BETA 10 + DE10 + A8080