

Sestava B&C Speakers 12HPL76-4 + DE400TN + Megaton A70/1260

Osazení:

- B&C Speakers 12HPL76-4 4/Ohm
<http://eshop.prodance.cz/DetailPage.asp?DPG=82709>
- B&C Speakers DE400TN 8/Ohm
<http://eshop.prodance.cz/DetailPage.asp?DPG=82308>
- Megaton A70/1260
<http://eshop.prodance.cz/DetailPage.asp?DPG=87810>

Schéma výhybky:

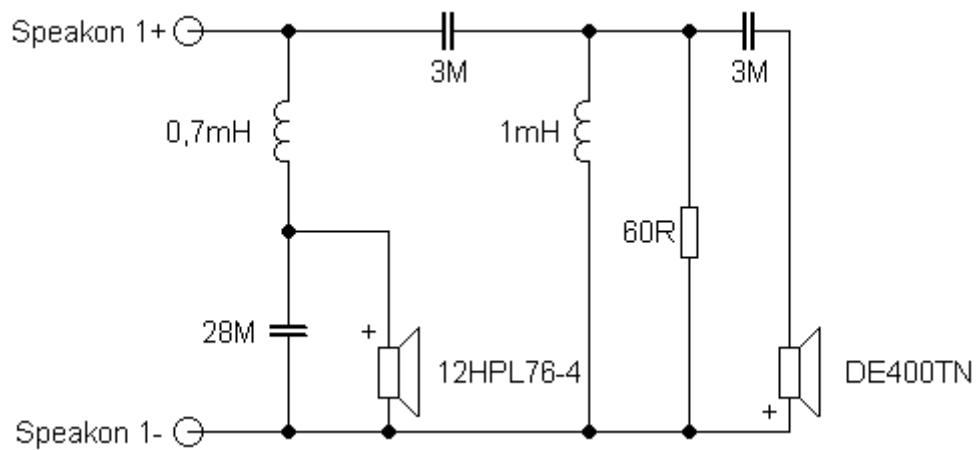

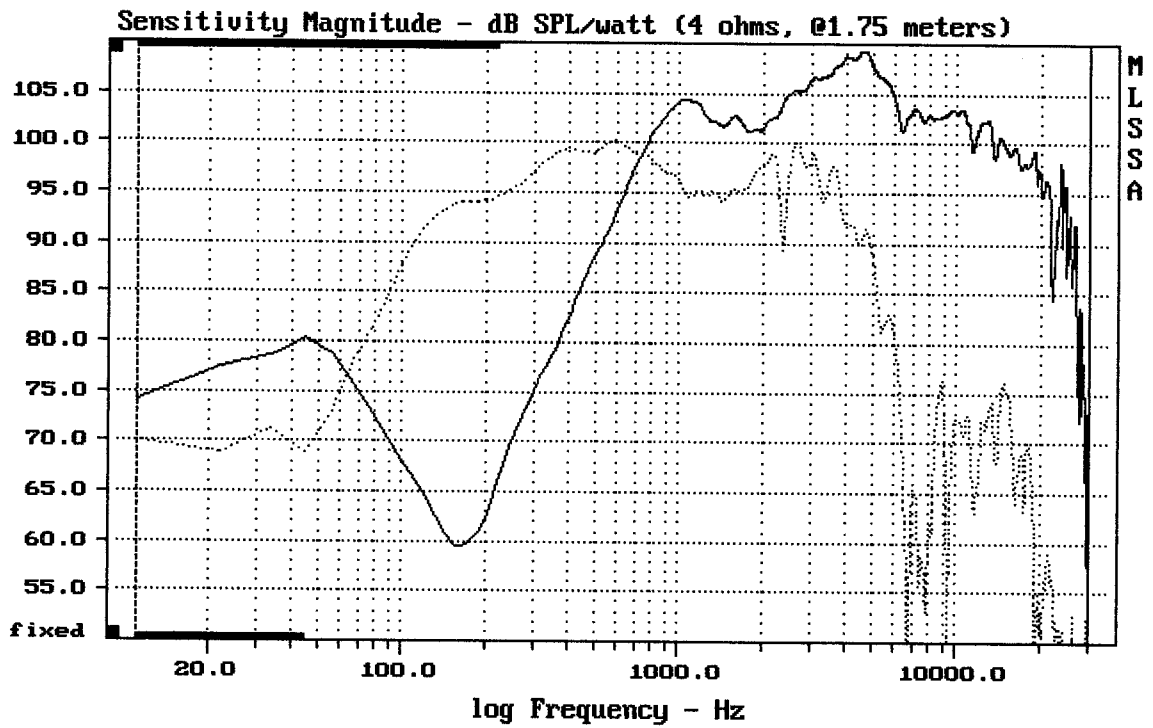

CURSOR: $dy = -35.3279$ $x = 30007.1014$ (2704)

12HPL76/4 + DE400TN + A70/1260

MLSSA: Frequency Domain

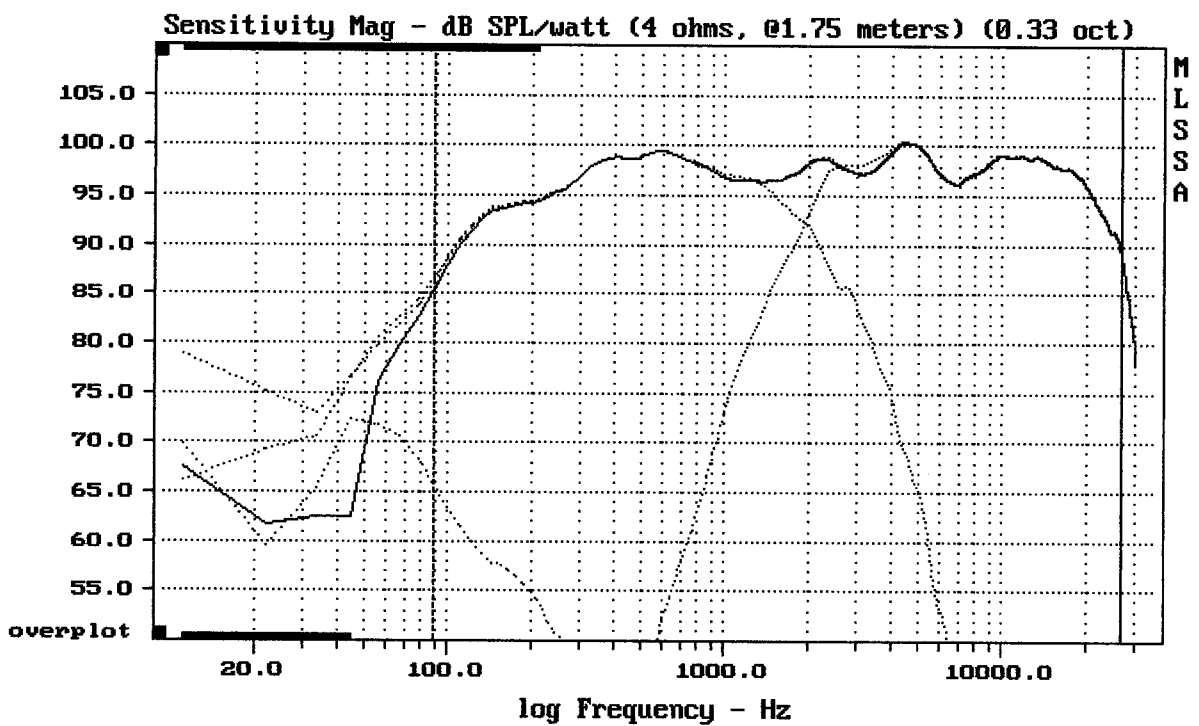

Level (89:27000 Hz) = 97.32 dB SPL/watt (4 ohms, @1.75 meters) (0.33 oct)

12HPL76/4 + DE400TN + A70/1260

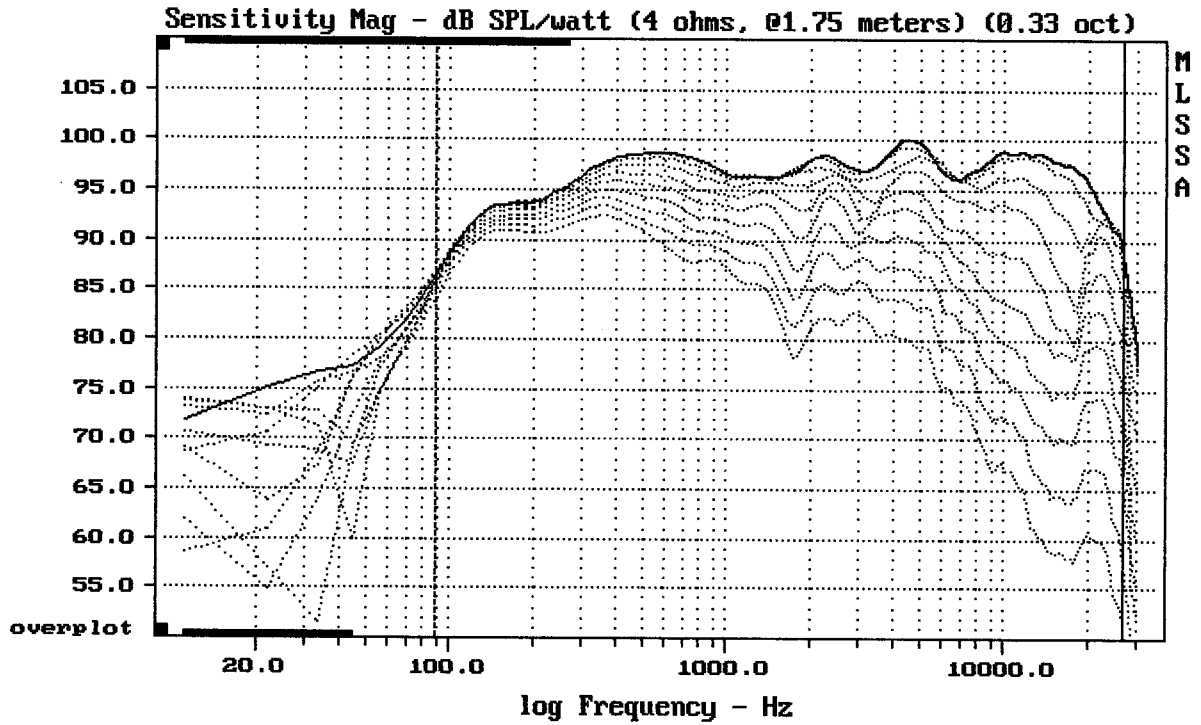

Overlay Compare: dev= +28/-9.2, std= 9.1, avg= -30

12HPL76/4 + DE400TN + A70/1260

MLSSA: Frequency Domain

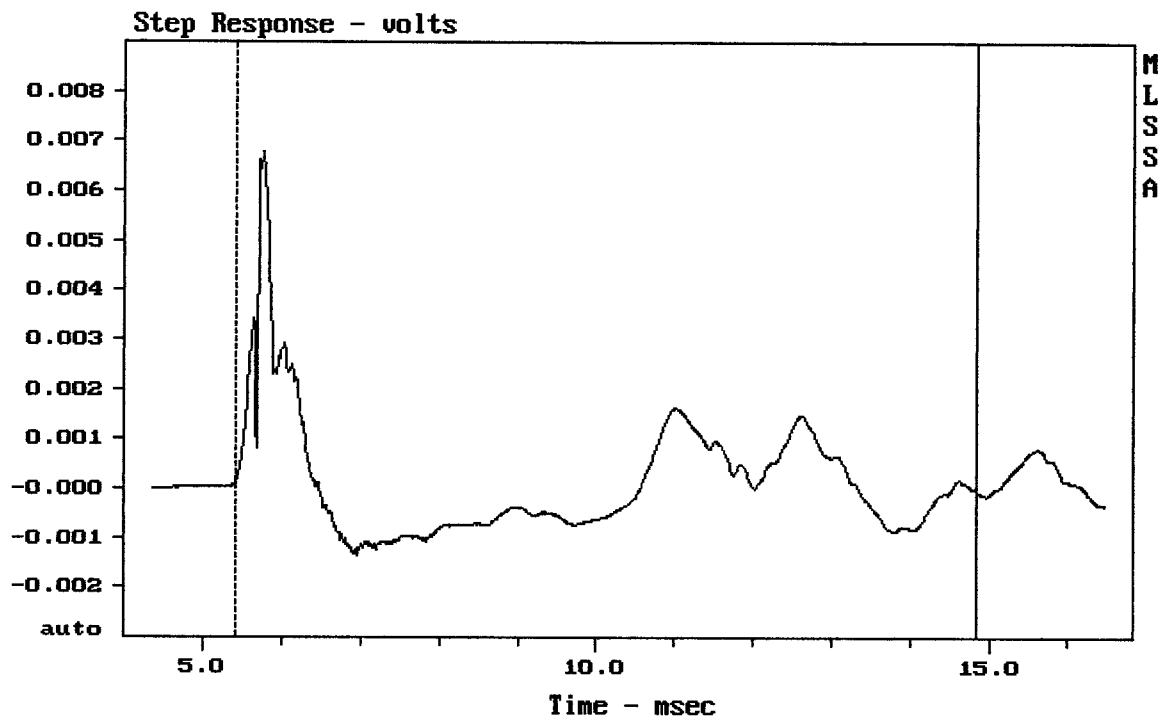

mean: 0.0001199, rms: 0.00123, std: 0.001224, max: 0.006768, min: -0.001359

12HPL76/4 + DE400TN + A70/1260

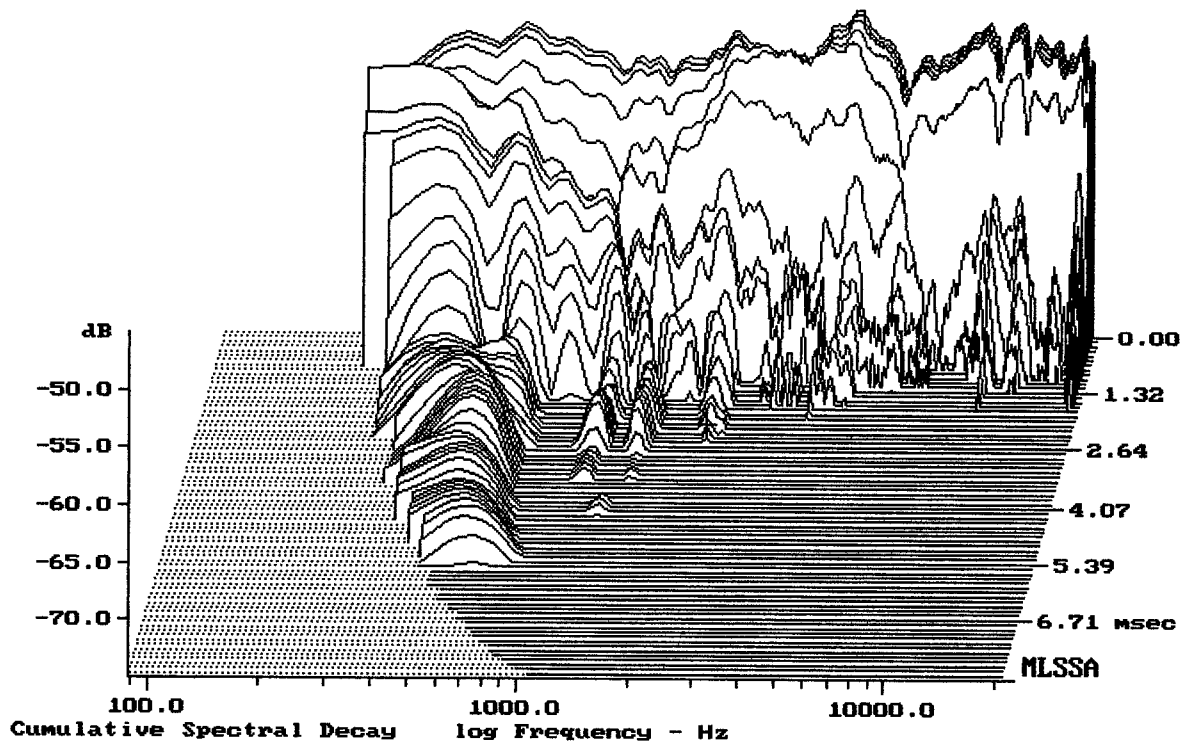

-74.31 dB, 2131 Hz (48), 2.310 msec (22)

DTTO

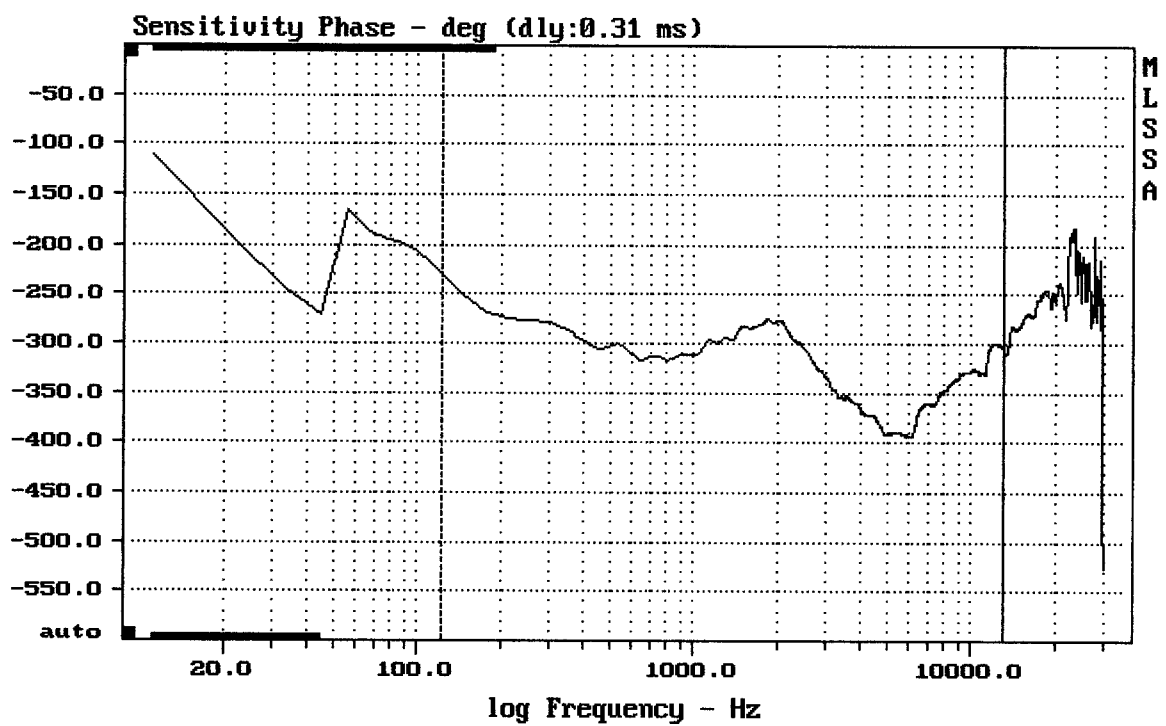

mean: -335.3, rms: 337, std: 33.18, max: -230.1, min: -393.8

12HPL76/4 + DE400TN + A70/1260

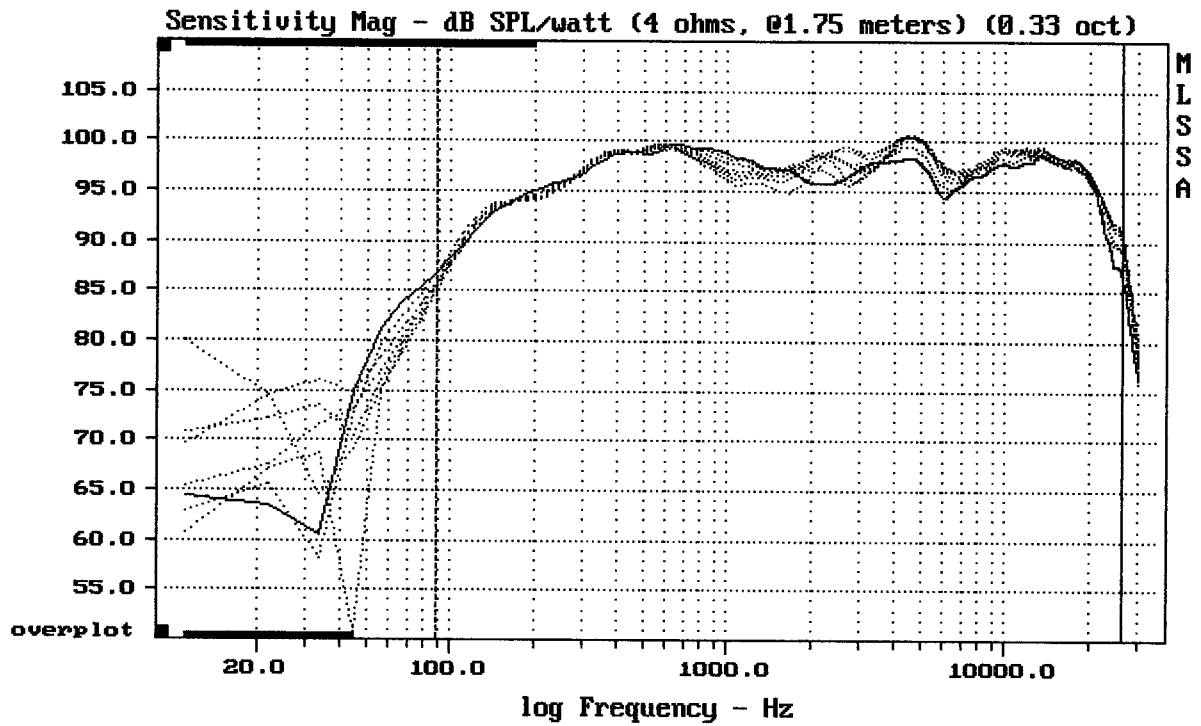

mean: 97.07, rms: 97.38, std: 2.08, max: 100.56, min: 86.89

12HPL76/4 + DE400TN + A70/1260

MLSSA: Frequency Domain

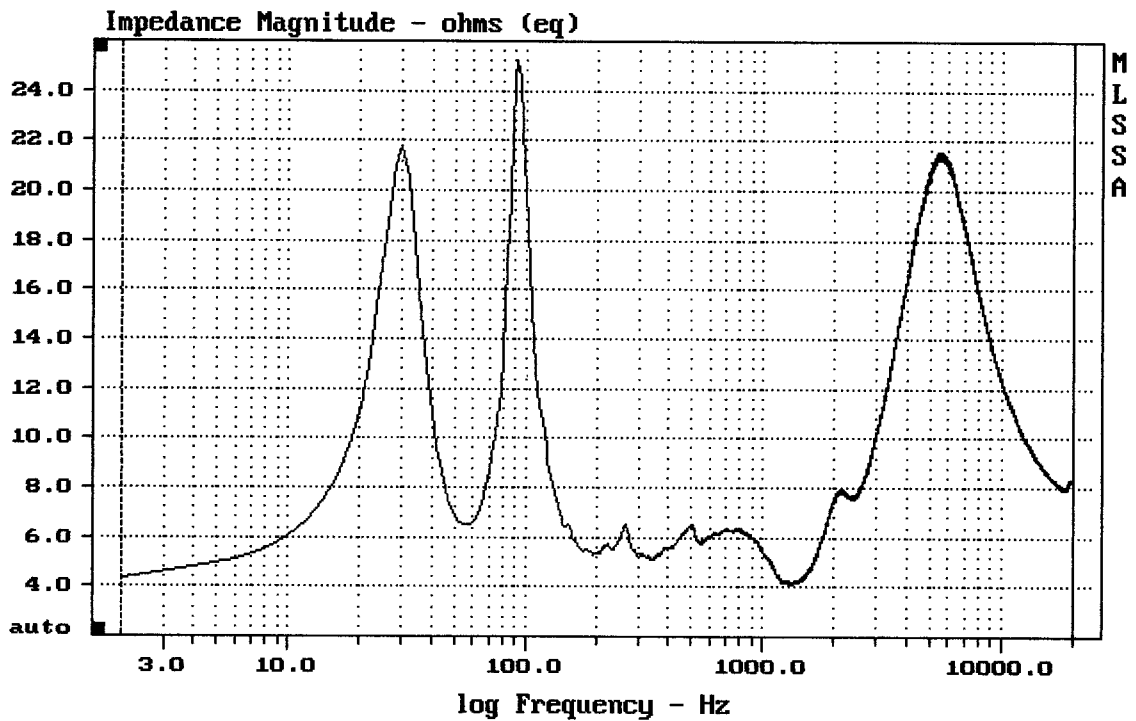

mean: 11.52, rms: 12.4, std: 4.597, max: 25.19, min: 4.088

12HPL76/4 + DE400TN + A70/1260