

Sestava B&C Speakers 12NDL76 + DE250 + ME45

Osazení:

- B&C Speakers 12NDL76 8/Ohm
<http://eshop.prodance.cz/DetailPage.asp?DPG=82724>
- B&C Speakers DE250 8/Ohm
<http://eshop.prodance.cz/DetailPage.asp?DPG=82306>
- B&C Speakers ME45
<http://eshop.prodance.cz/DetailPage.asp?DPG=79828>

Schéma výhybky:

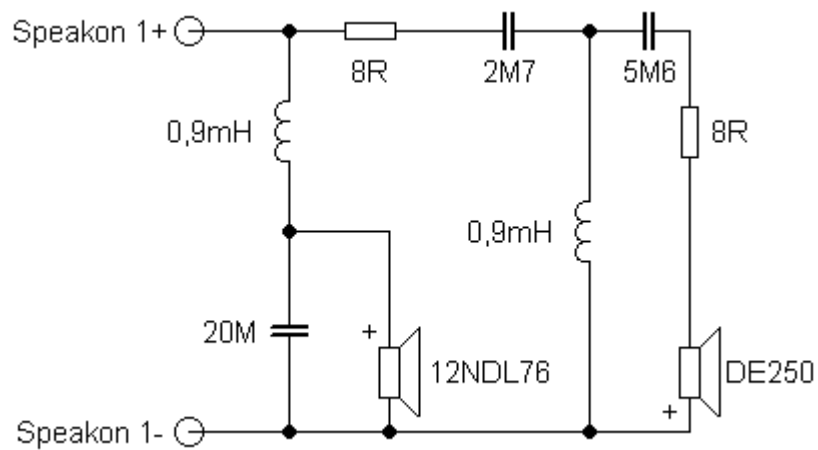

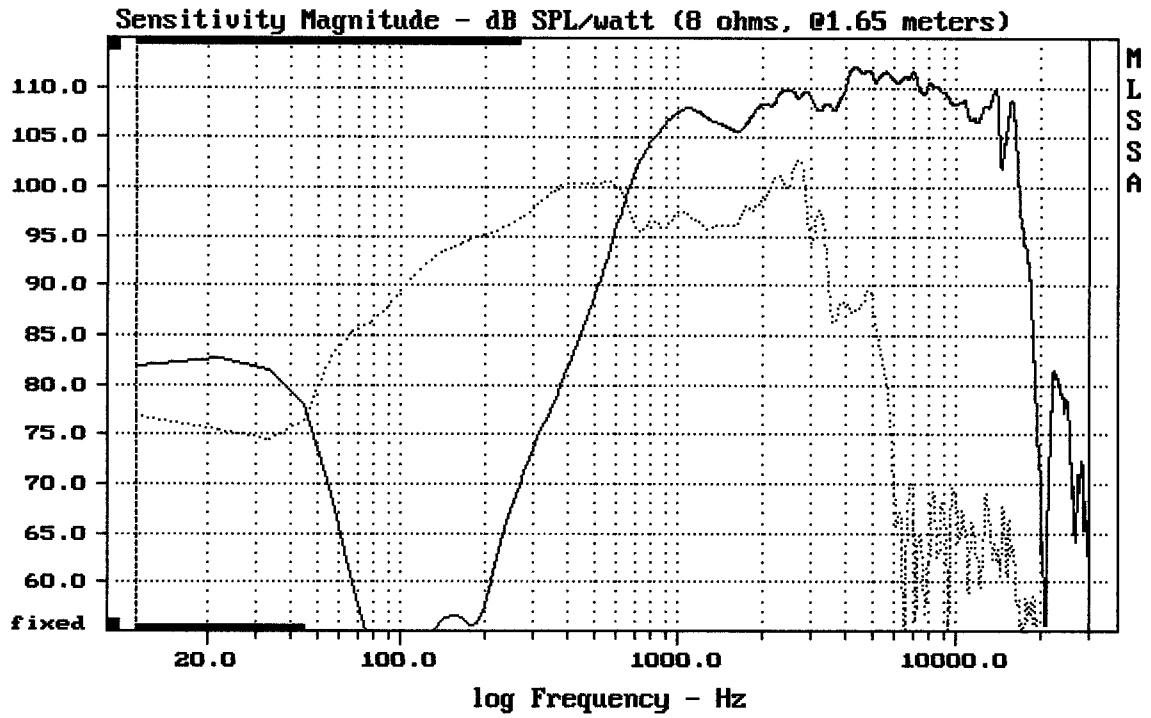

CURSOR: dy = -21.0279 x = 30007.1014 (2704)

12NDL76 + DE250 + ME45

MLSSA: Frequency Domain

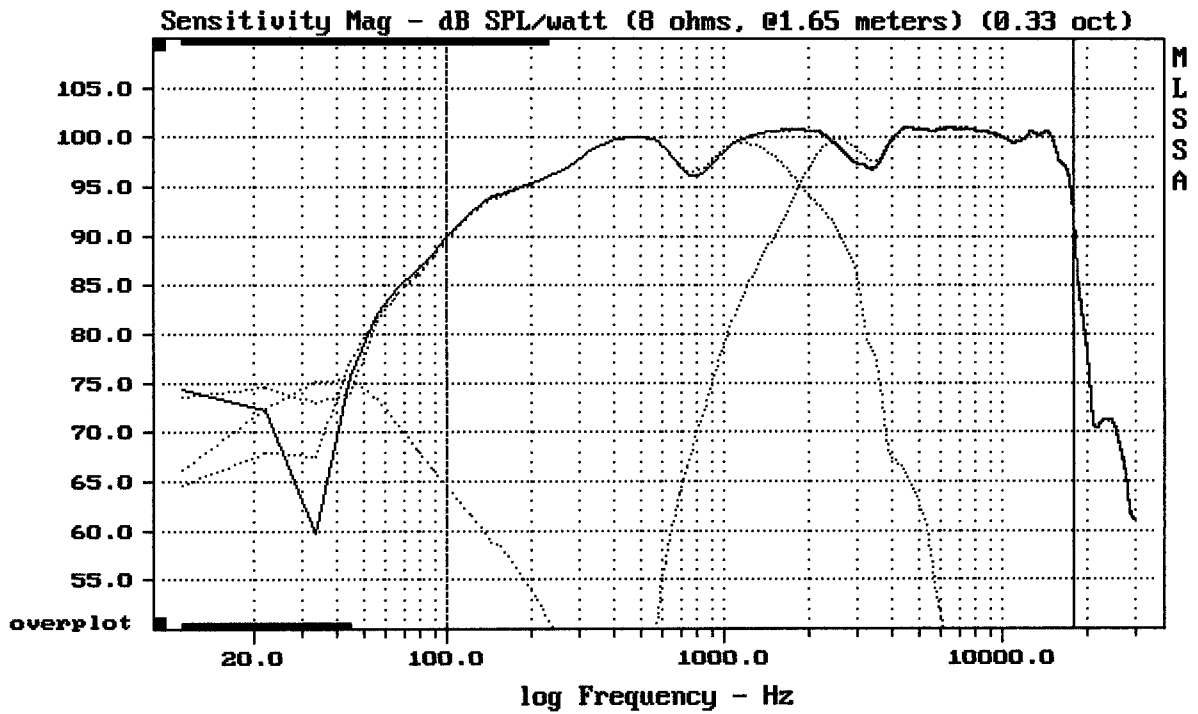

Level (100:10011 Hz) = 98.98 dB SPL/watt (8 ohms, @1.65 meters) (0.33 oct)

12NDL76 + DE250 + ME45

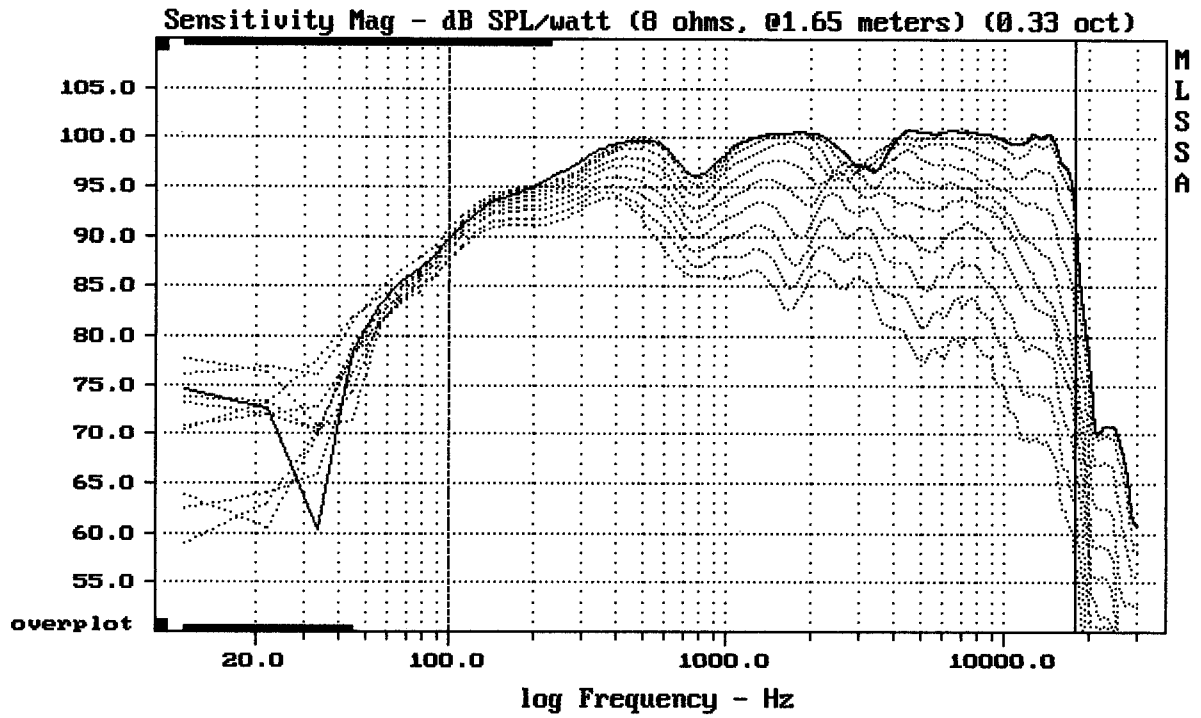

Overlay Compare: dev= +22/-11, std= 7.8, avg= -24

12NDL76 + DE250 + ME45

MLSSA: Frequency Domain

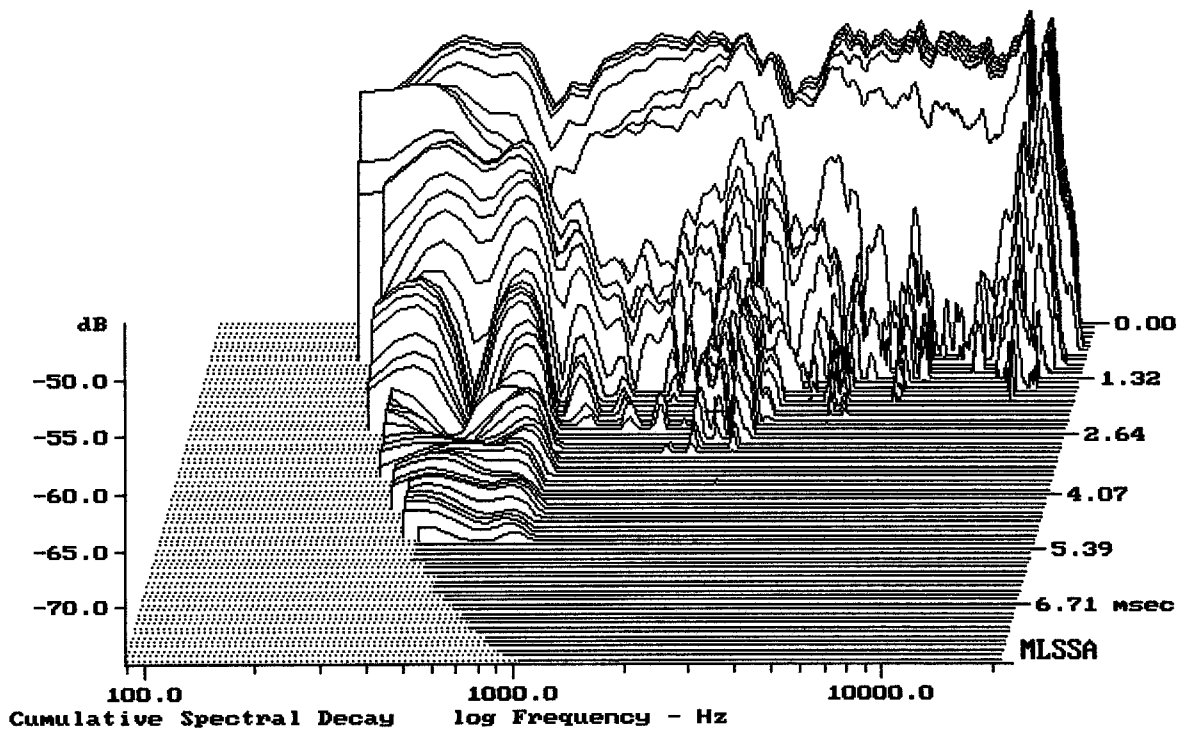

-72.96 dB, 2353 Hz (53), 2.640 msec (25)

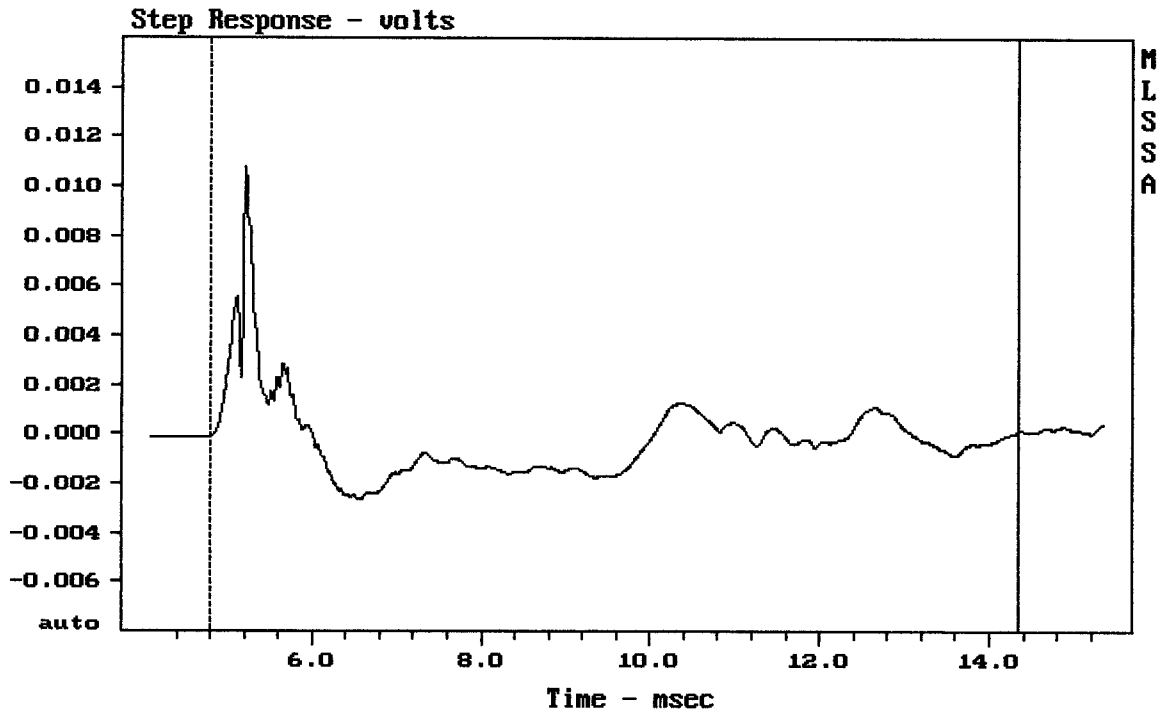

mean: -0.0002431, rms: 0.001654, std: 0.001636, max: 0.01074, min: -0.002655

12NDL76 + DE250 + ME45

MLSSA: Time Domain

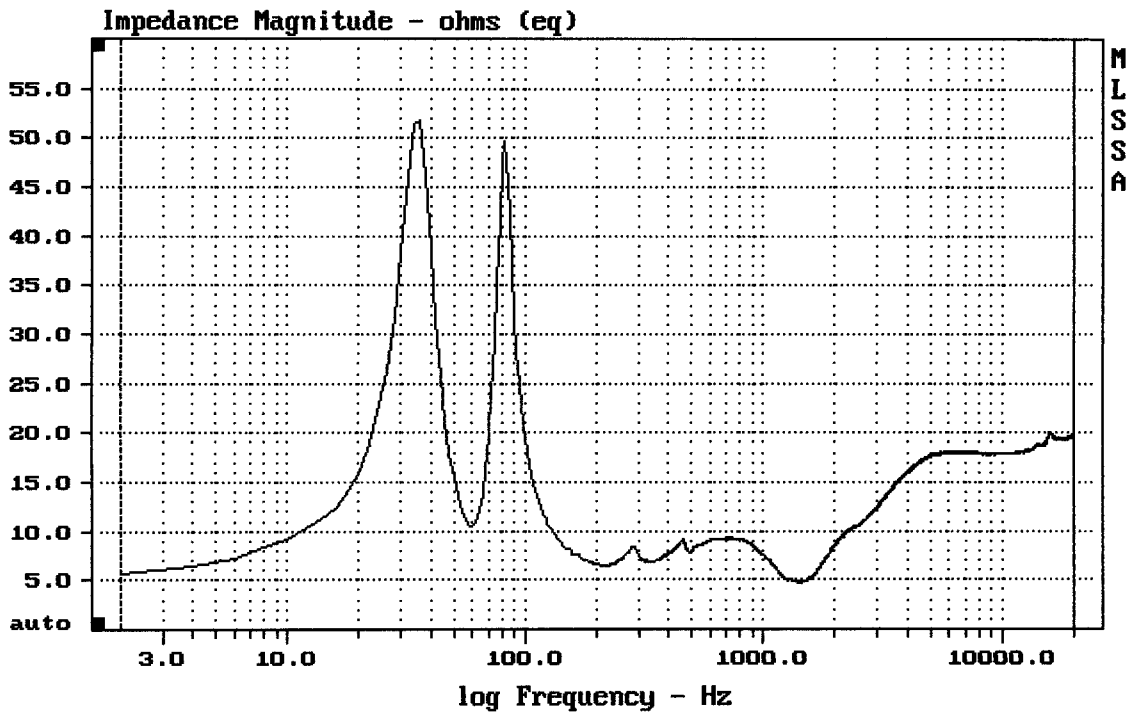

mean: 16.83, rms: 17.28, std: 3.915, max: 51.77, min: 4.731

12NDL76 + DE250 + ME45