

## Sestava B&C Speakers 12HPL76 + DE250 + Fane FH290

### Osazení:

- B&C Speakers 12HPL76 8/Ohm

<http://eshop.prodance.cz/DetailPage.asp?DPG=82710>

- B&C Speakers DE250 8/Ohm

<http://eshop.prodance.cz/DetailPage.asp?DPG=82306>

- Fane FH290

<http://eshop.prodance.cz/DetailPage.asp?DPG=81782>

### Schéma výhybky:

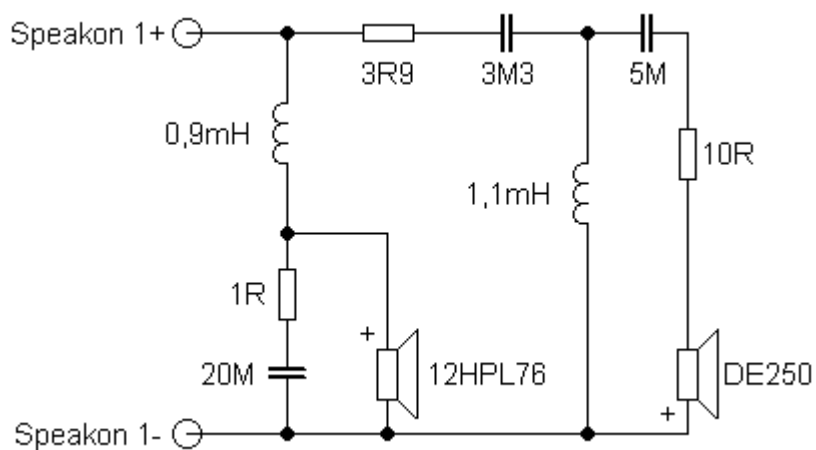

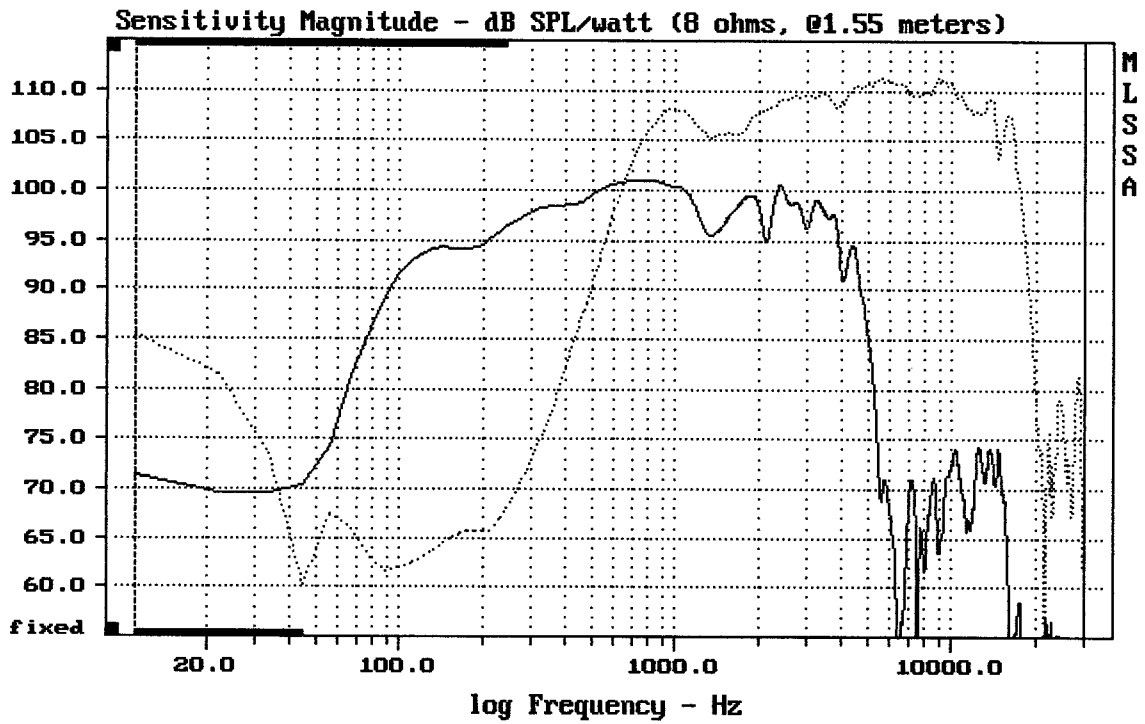

CURSOR: dy = 15.9887 x = 30007.1014 (2704)

12HPL76 + DE250 + FH290

MLSSA: Frequency Domain

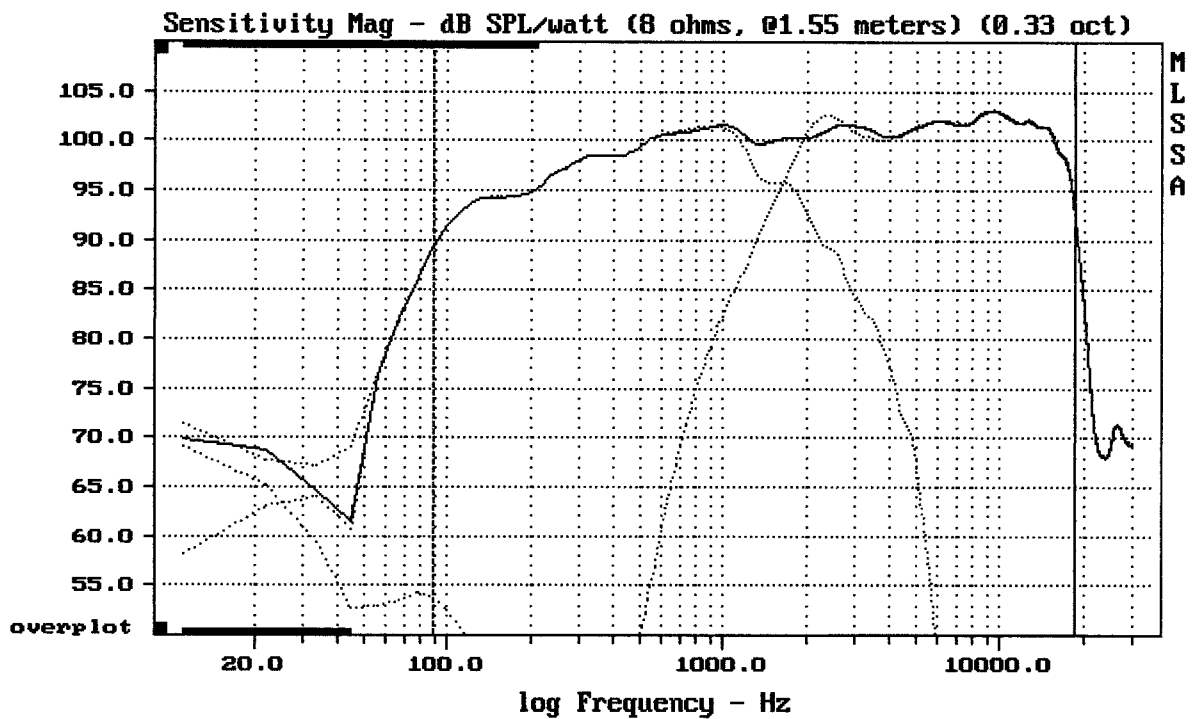

Level (89:18599 Hz) = 100.03 dB SPL/watt (8 ohms, @1.55 meters) (0.33 oct)

12HPL76 + DE250 + FH290

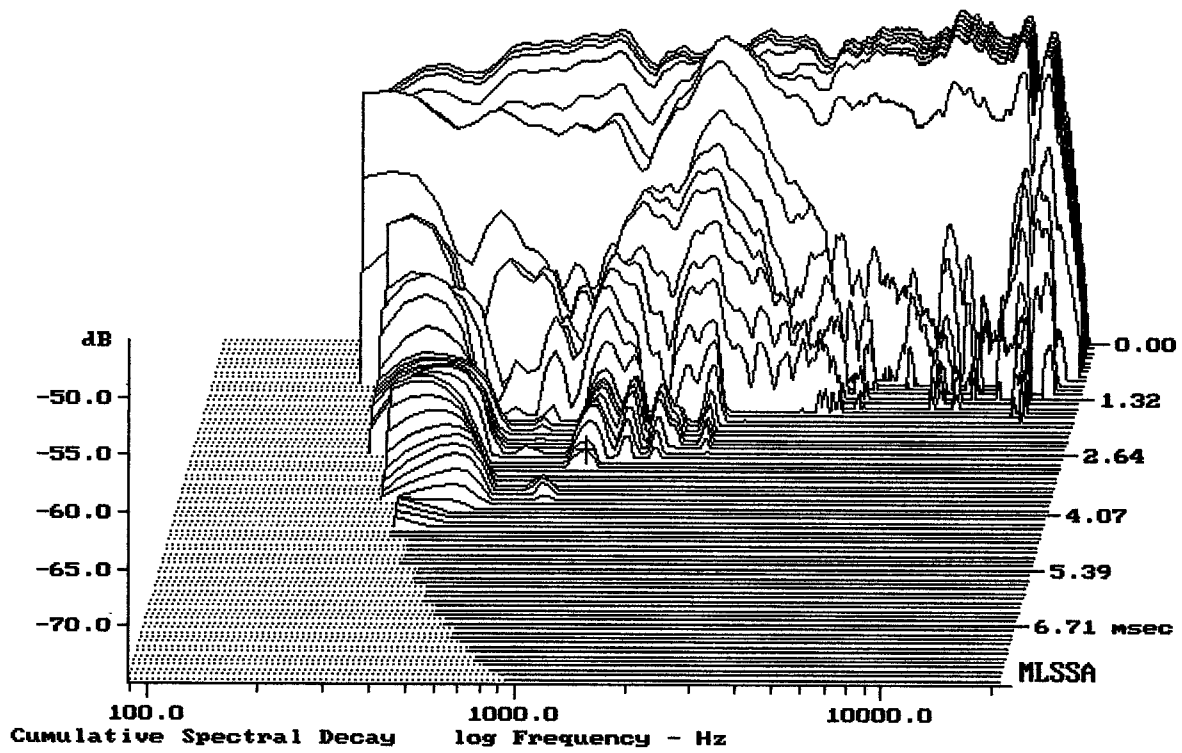

-73.57 dB, 1065 Hz (24), 2.970 msec (28)

DTTO

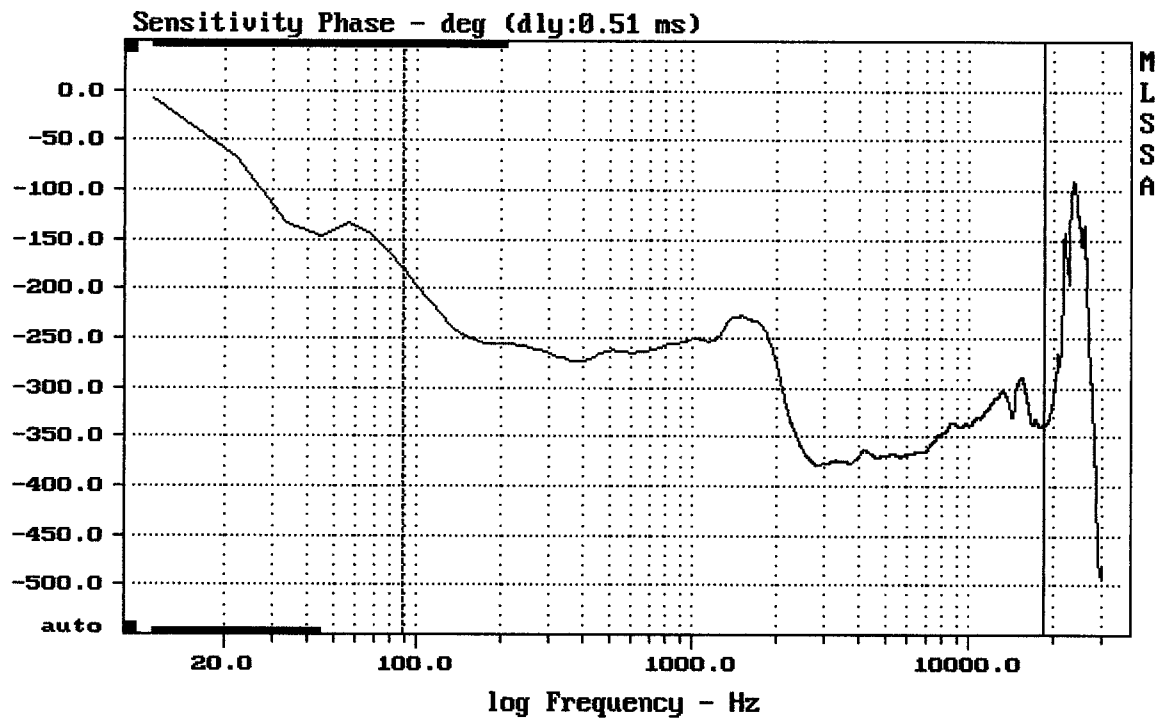

mean: -328.6, rms: 330.6, std: 36.06, max: -180.1, min: -378.6

12HPL76 + DE250 + FH290

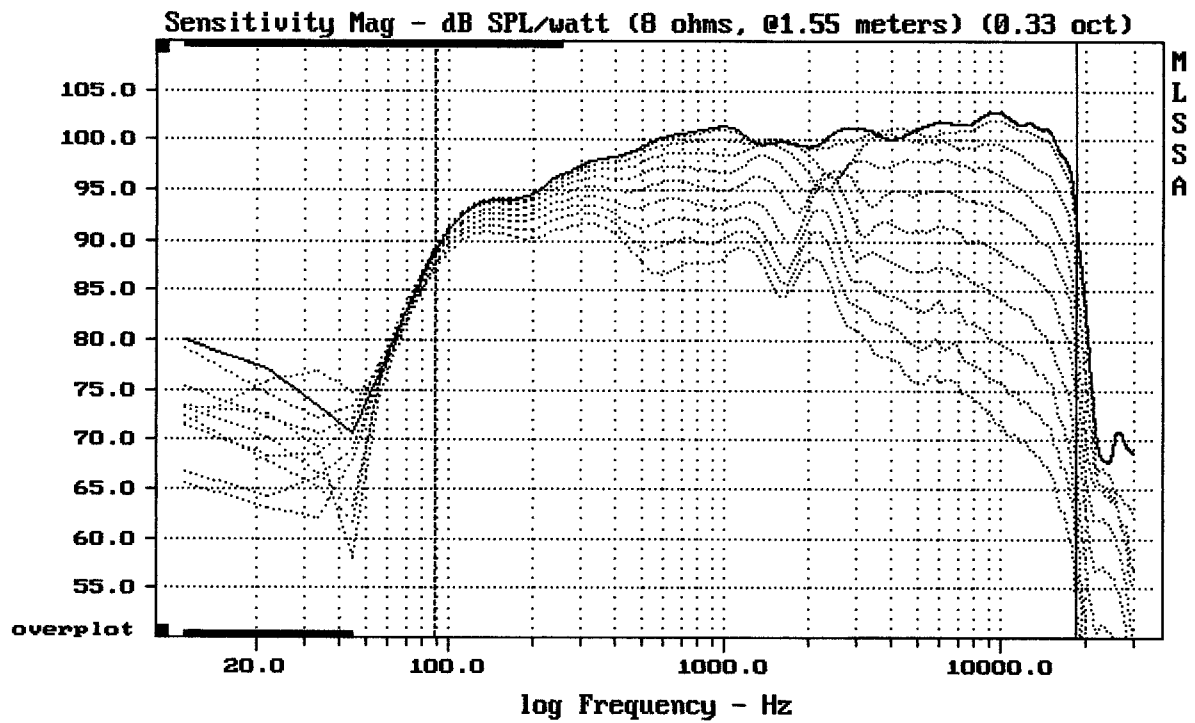

Overlay Compare: dev= +26/-11, std= 7.8, avg= -28

12HPL76 + DE250 + FH290

MLSSA: Frequency Domain

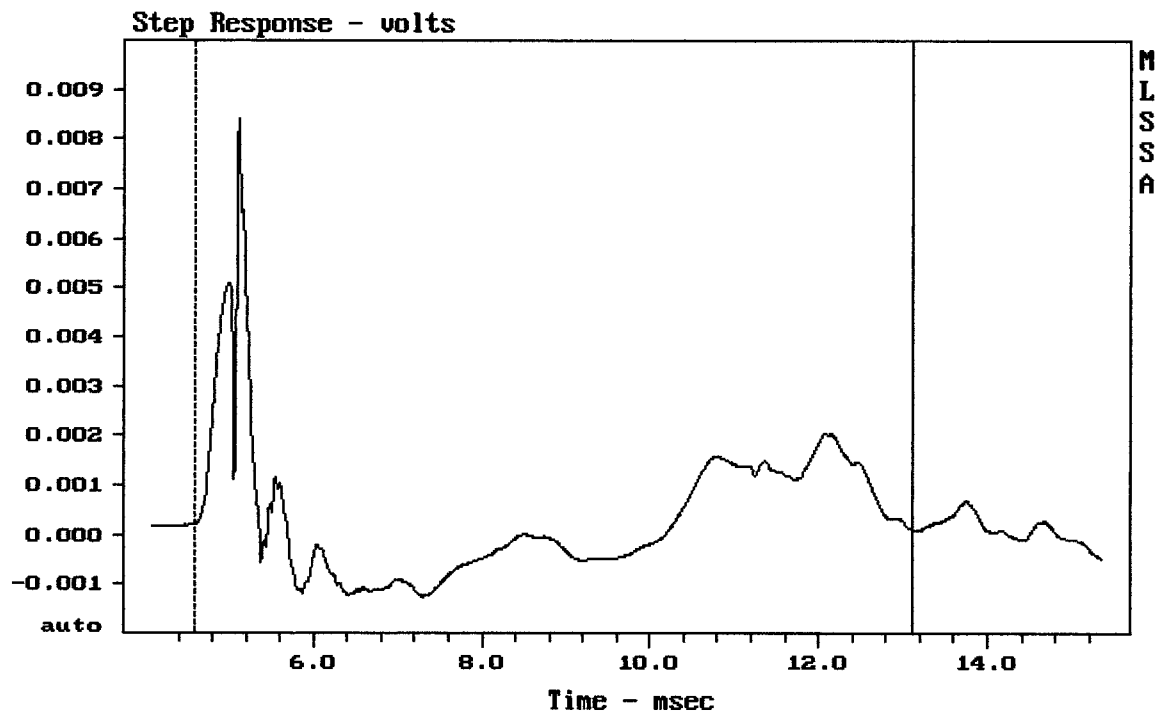

mean: 0.0003786, rms: 0.001461, std: 0.001411, max: 0.008421, min: -0.001243

12HPL76 + DE250 + FH290

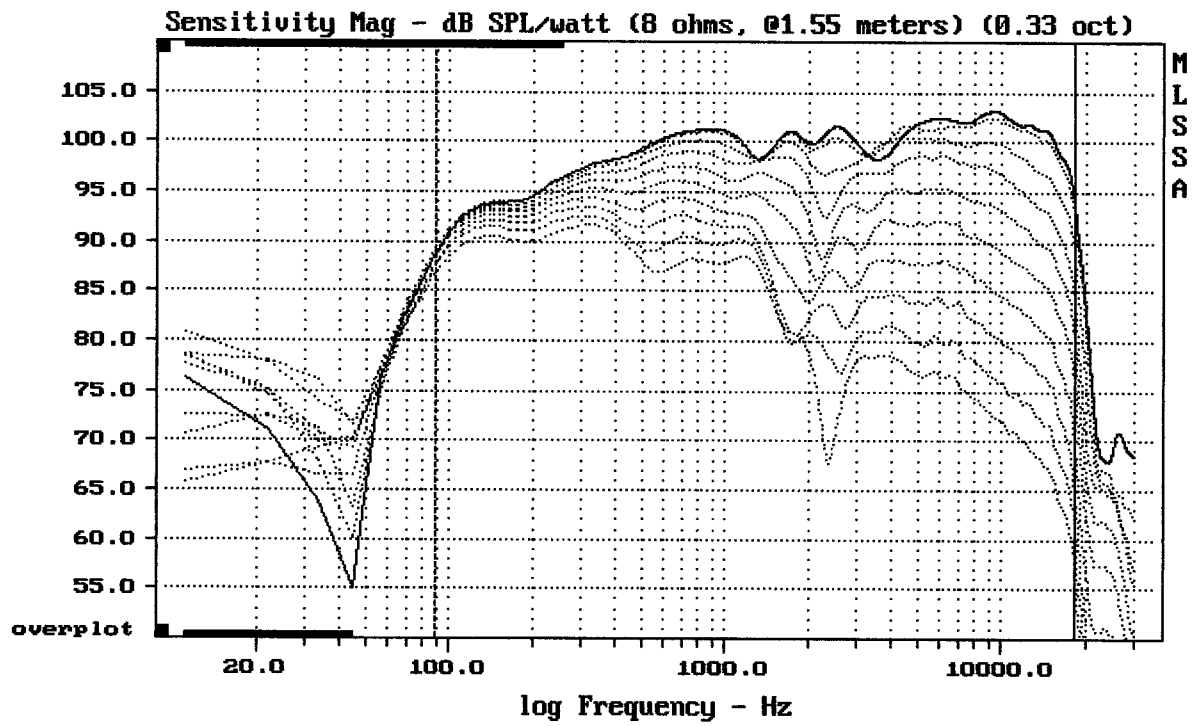

Overlay Compare: dev= +26/-8.6, std= 6.9, avg= -28

12HPL76 + DE250 + FH290

MLSSA: Frequency Domain

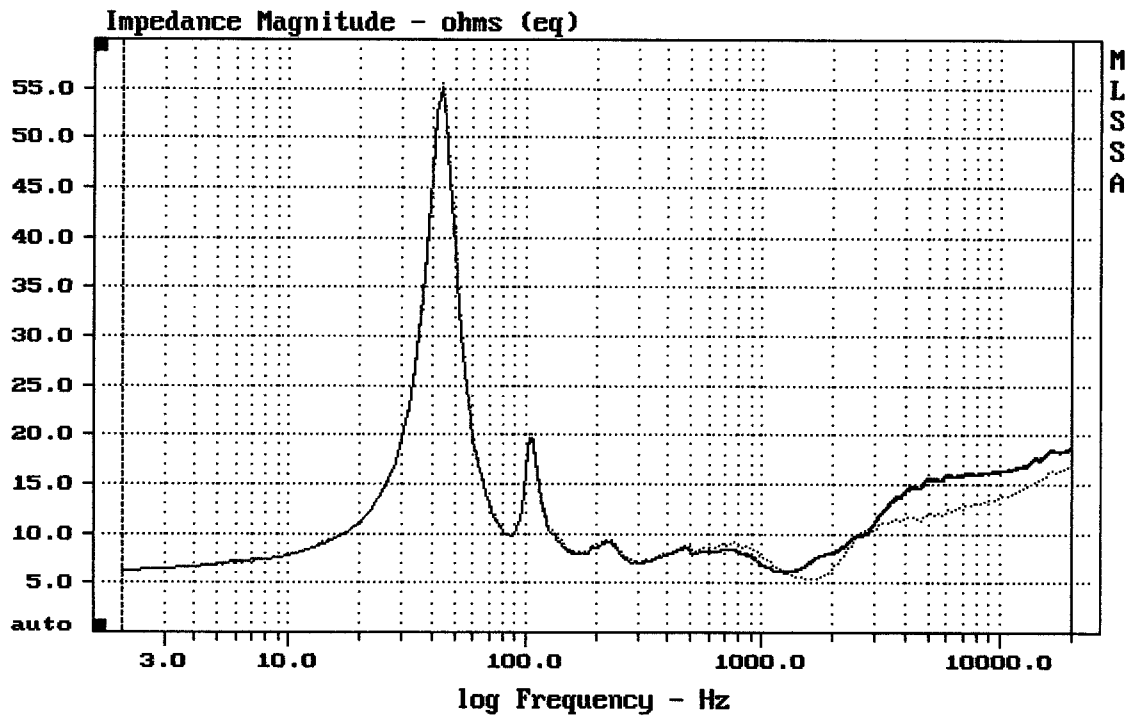

mean: 13.3, rms: 13.63, std: 2.988, max: 55.48, min: 5.428

12HPL76 + DE250 + FH290