

Sestava B&C Speakers 15NDL76 + DE400TN + Megaton A9090

Osazení:

- B&C Speakers 15NDL76 8/Ohm
<http://eshop.prodance.cz/DetailPage.asp?DPG=82860>
- B&C Speakers DE400TN 8/Ohm
<http://eshop.prodance.cz/DetailPage.asp?DPG=82308>
- Megaton A9090
<http://eshop.prodance.cz/DetailPage.asp?DPG=83920>

Schéma výhybky:

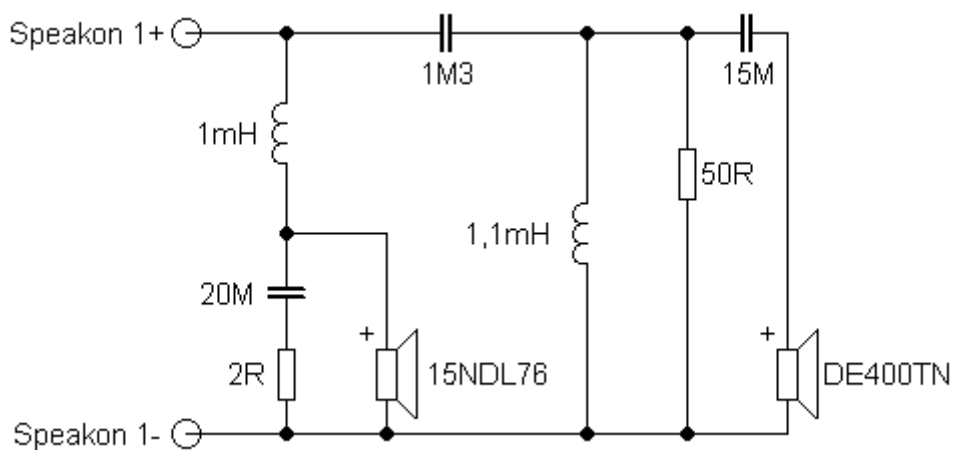

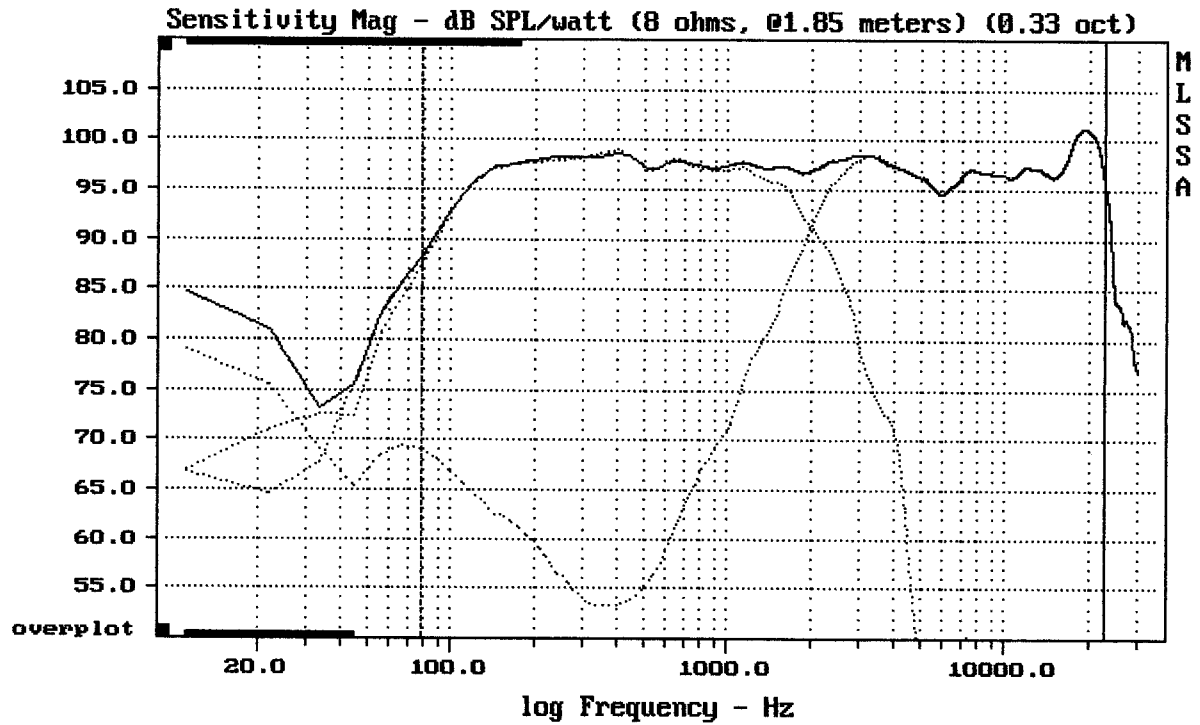

Level (78:23005 Hz) = 97.35 dB SPL/watt (8 ohms, @1.85 meters) (0.33 oct)

15NDL76 + DE400TN + A9090

MLSSA: Frequency Domain

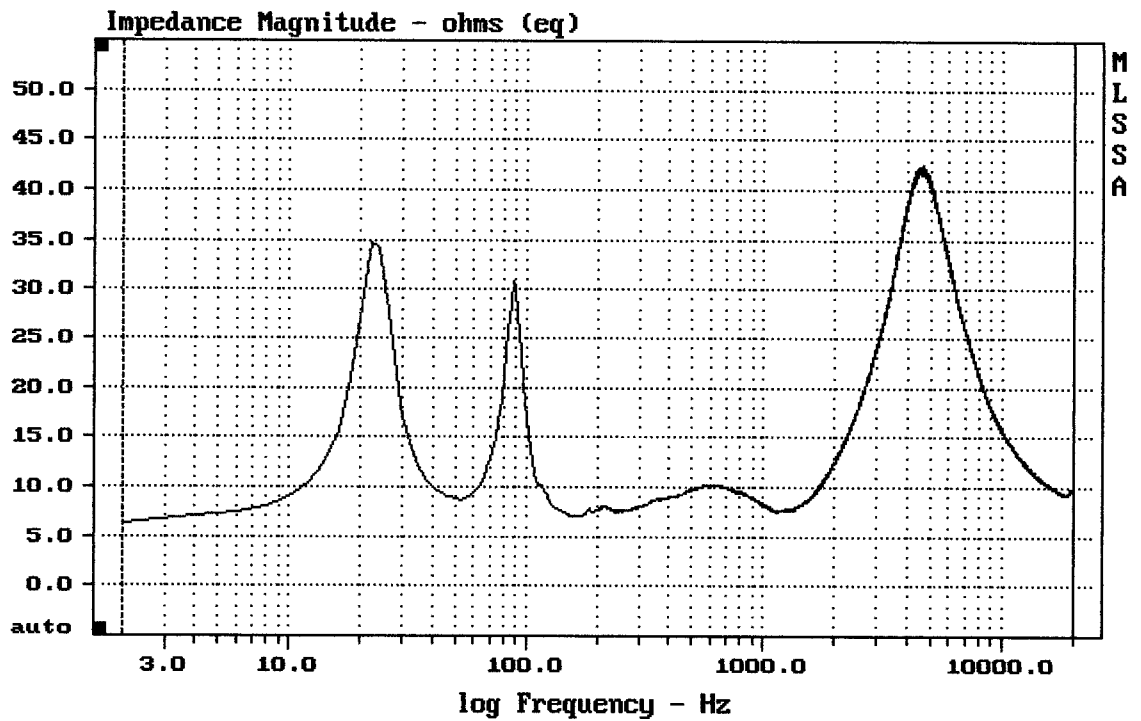

mean: 17.32, rms: 19.89, std: 9.776, max: 42.54, min: 6.239

15NDL76 + DE400TN + A9090

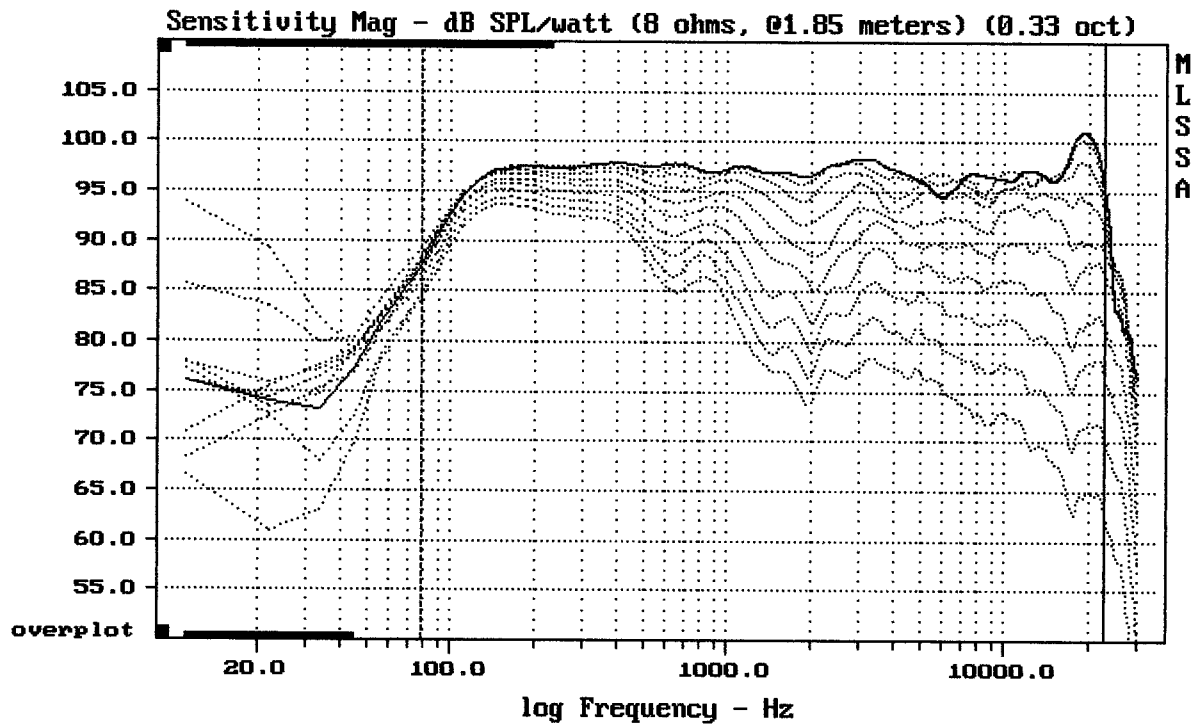

Overlay Compare: dev= +23/-11, std= 7, avg= -26

15NDL76 + DE400TN + A9090

MLSSA: Frequency Domain

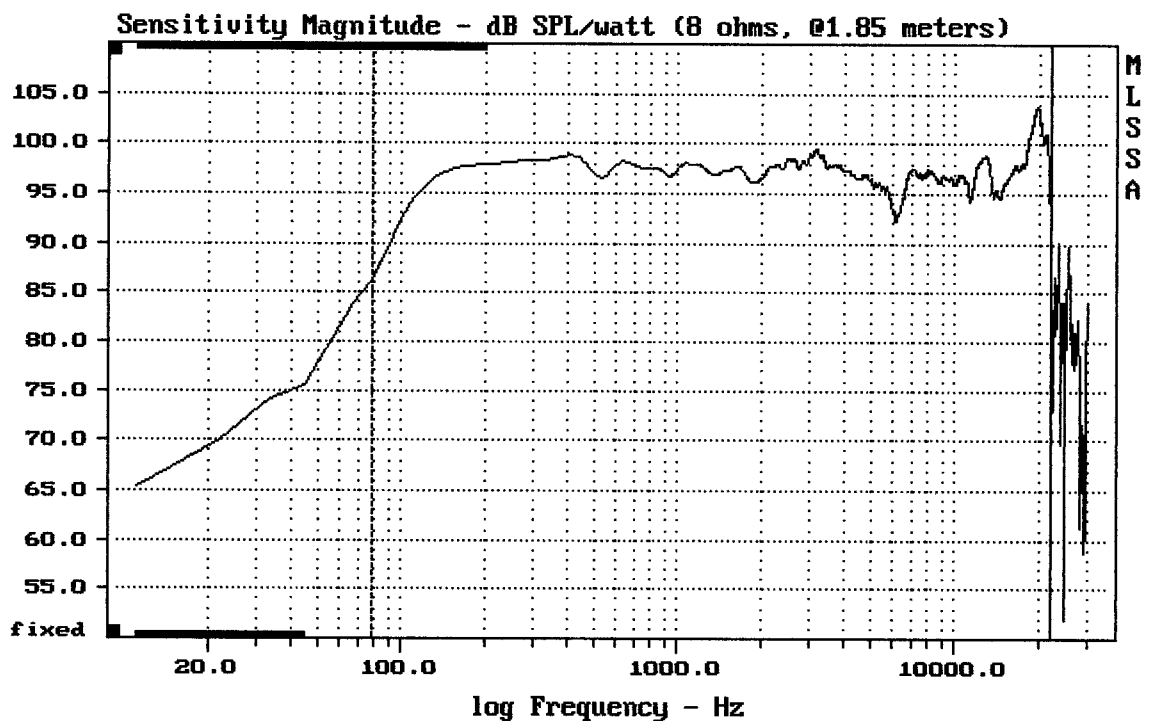

mean: 97.86, rms: 98.20, std: 2.18, max: 103.77, min: 86.32

15NDL76 + DE400TN + A9090

Step Response - volts

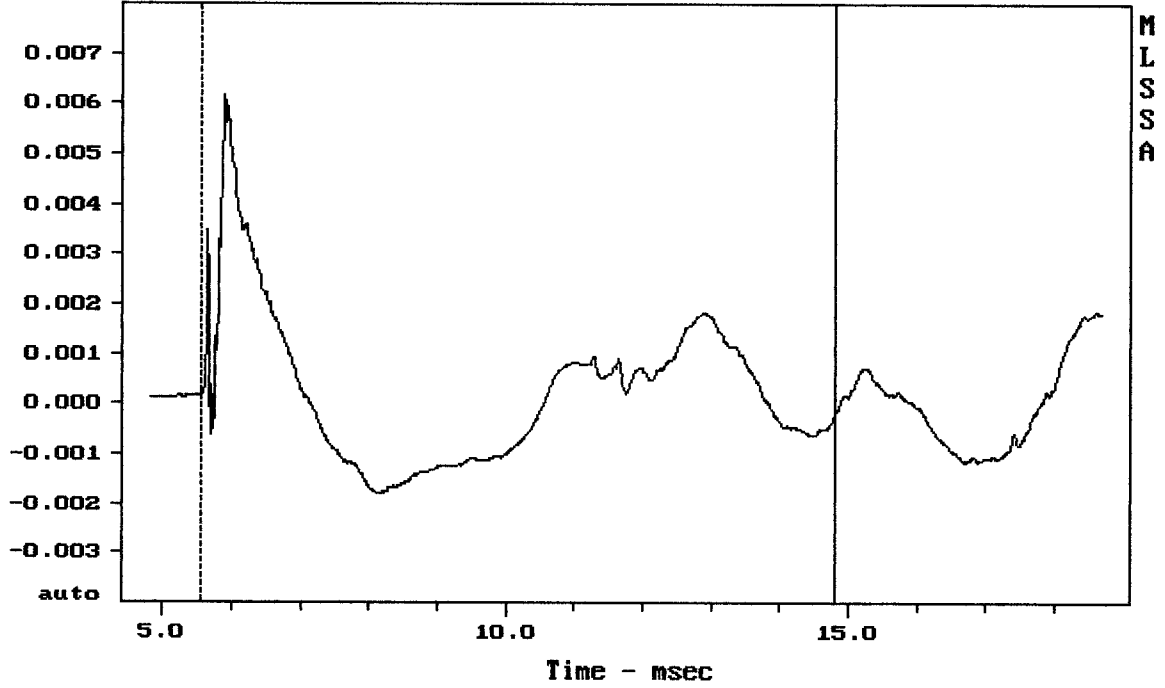

mean: 0.0002293, rms: 0.001492, std: 0.001474, max: 0.006172, min: -0.001793

15NDL76 + DE400TN + A9090

MLSSA: Time Domain

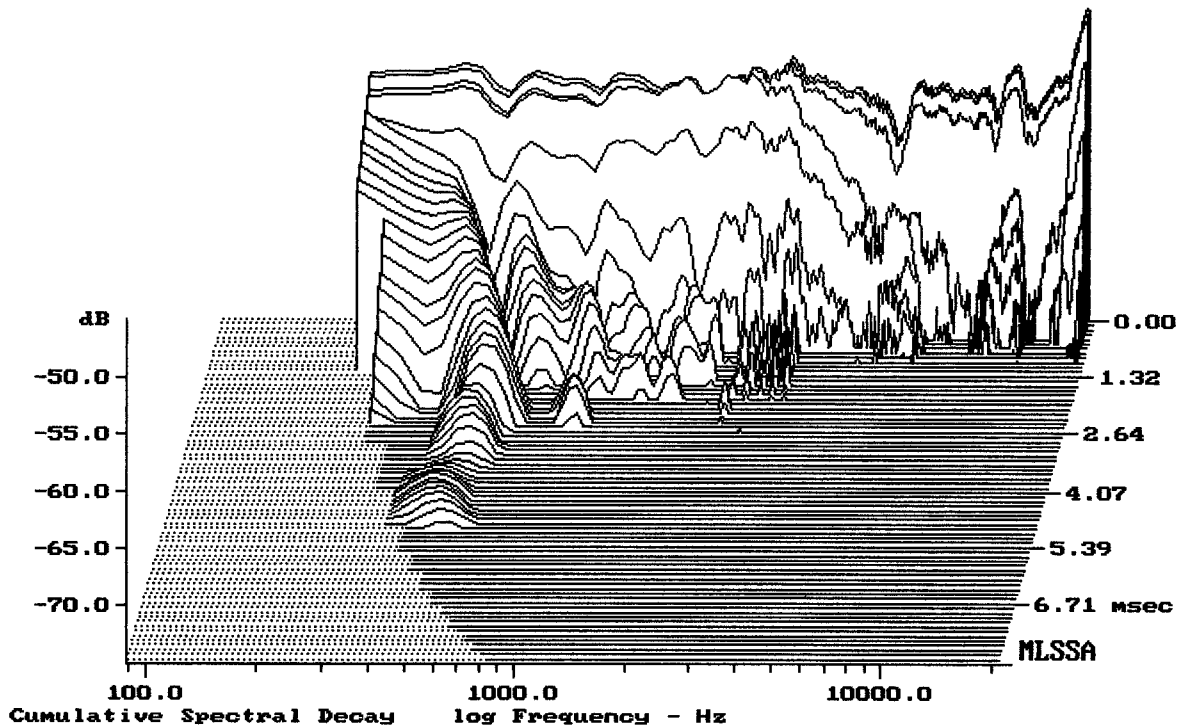

-75.00 dB, 3018 Hz (68), 1.320 msec (13)