

Sestava Eminence Delta-15LF + PSD2002 + Fane FH305

Osazení:

- Eminence Delta-15LF 8/Ohm

<http://eshop.prodance.cz/DetailPage.asp?DPG=82363>

- Eminence PSD2002 8/Ohm

<http://eshop.prodance.cz/DetailPage.asp?DPG=88956>

- Fane FH305

<http://eshop.prodance.cz/DetailPage.asp?DPG=81783>

Schéma výhybky:

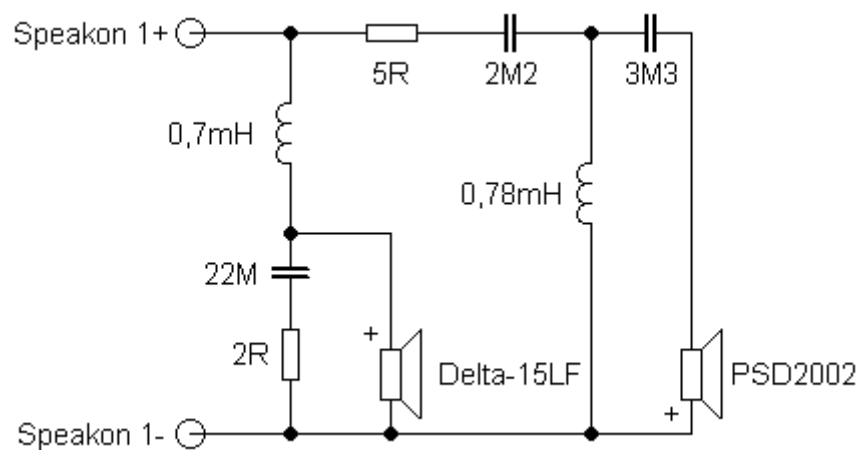

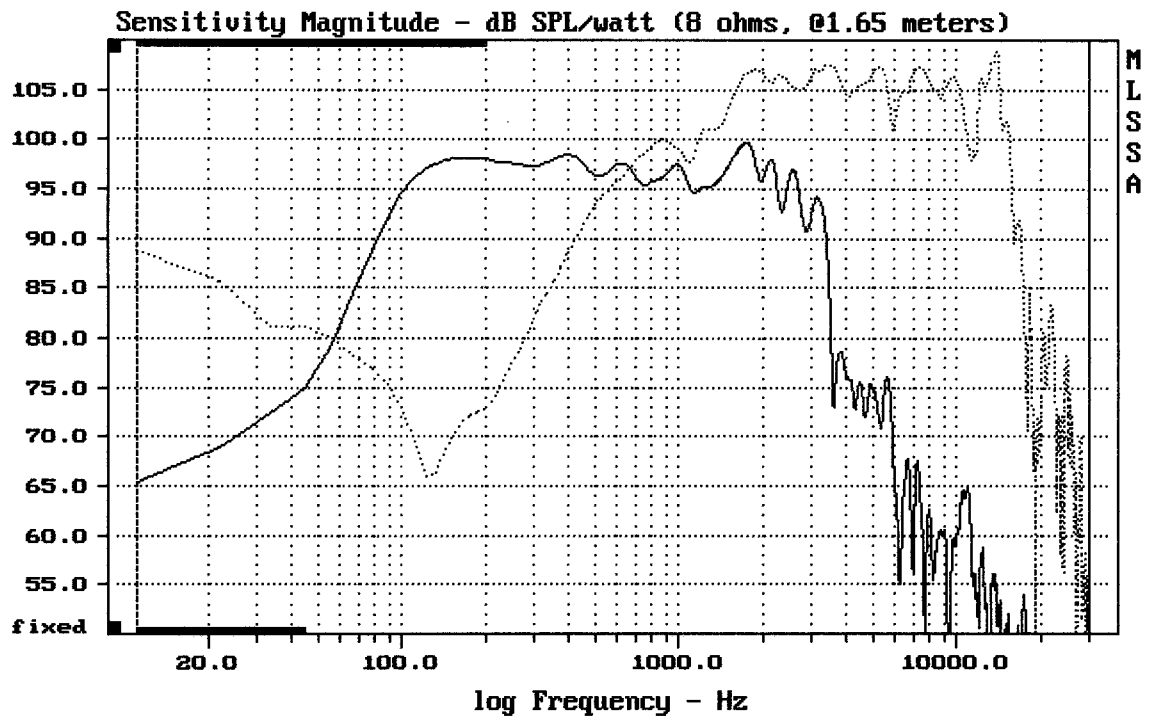

CURSOR: dy = 15.5389 x = 30007.1014 (2704)

DELTA15LF + PSD2002 + FH305

MLSSA: Frequency Domain

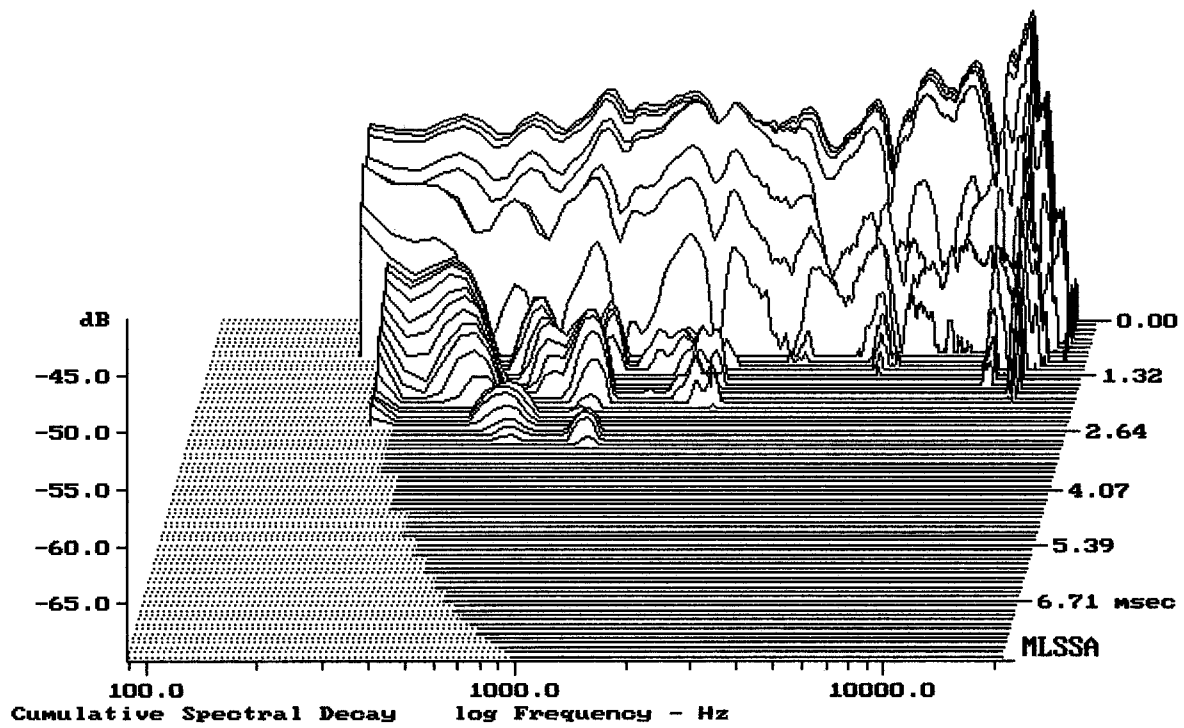

-67.38 dB, 2175 Hz (49), 1.980 msec (19)

DTTO

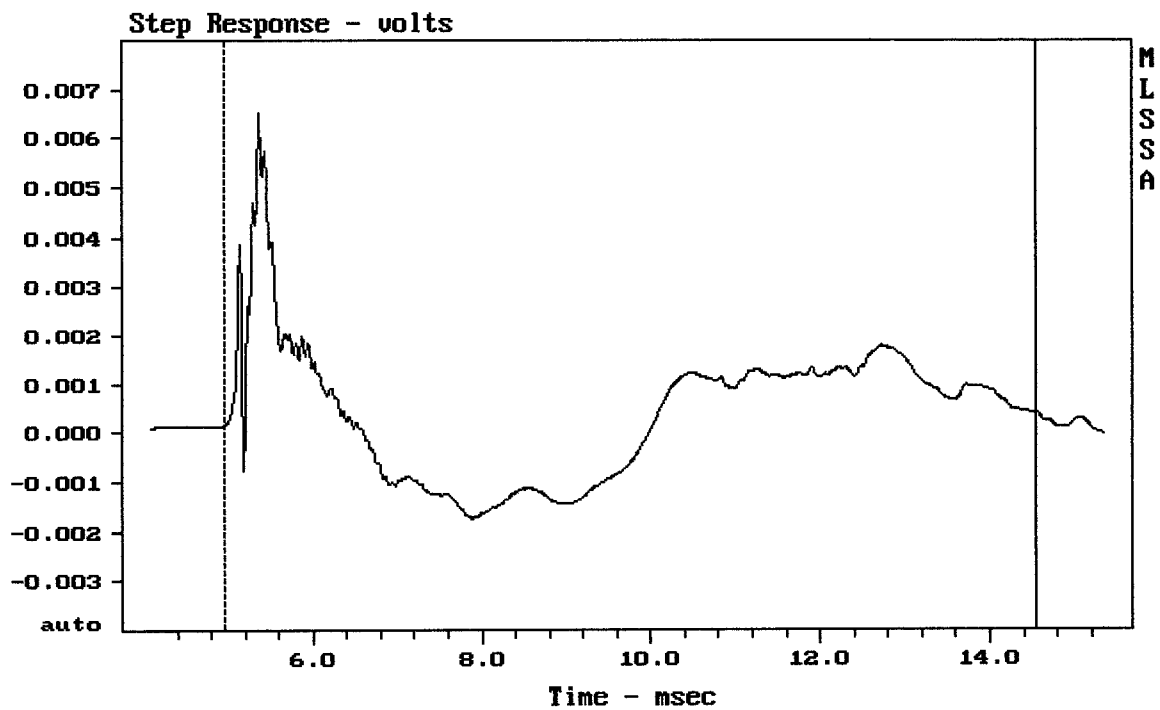

mean: 0.0004188, rms: 0.001438, std: 0.001376, max: 0.006522, min: -0.001725

DELTA15LF + PSD2002 + FH305

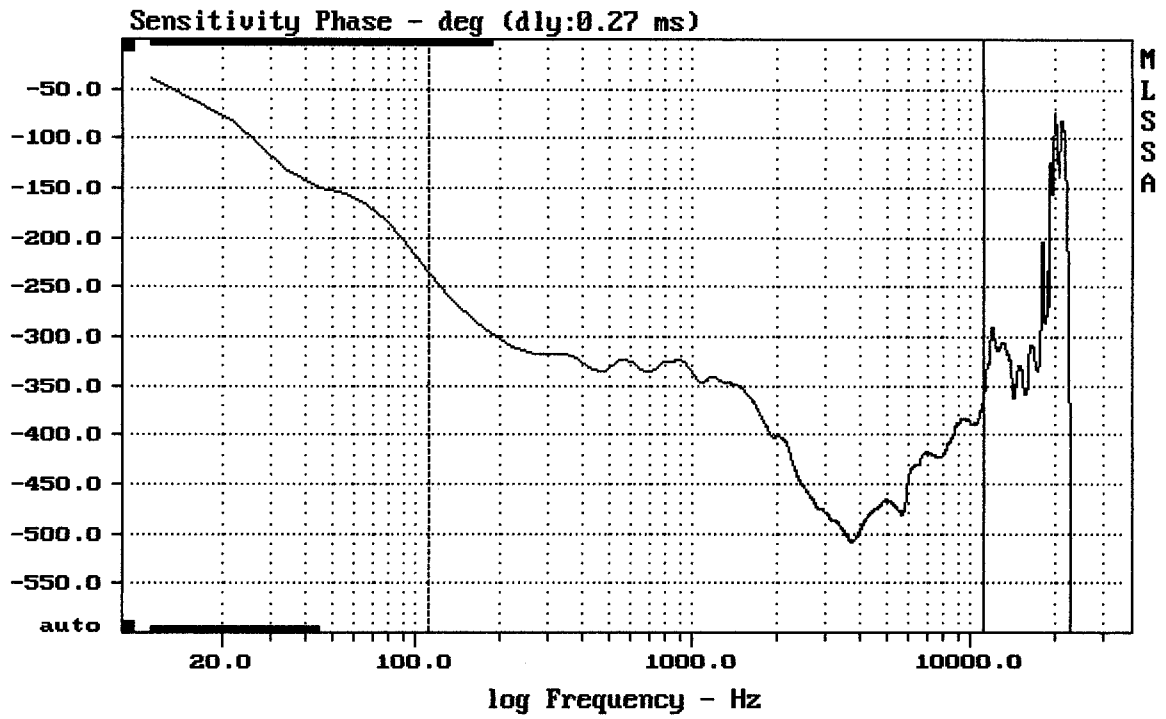

mean: -417.9, rms: 421.1, std: 51.62, max: -234.8, min: -508.1

DELTA15LF + PSD2002 + FH305

MLSSA: Frequency Domain

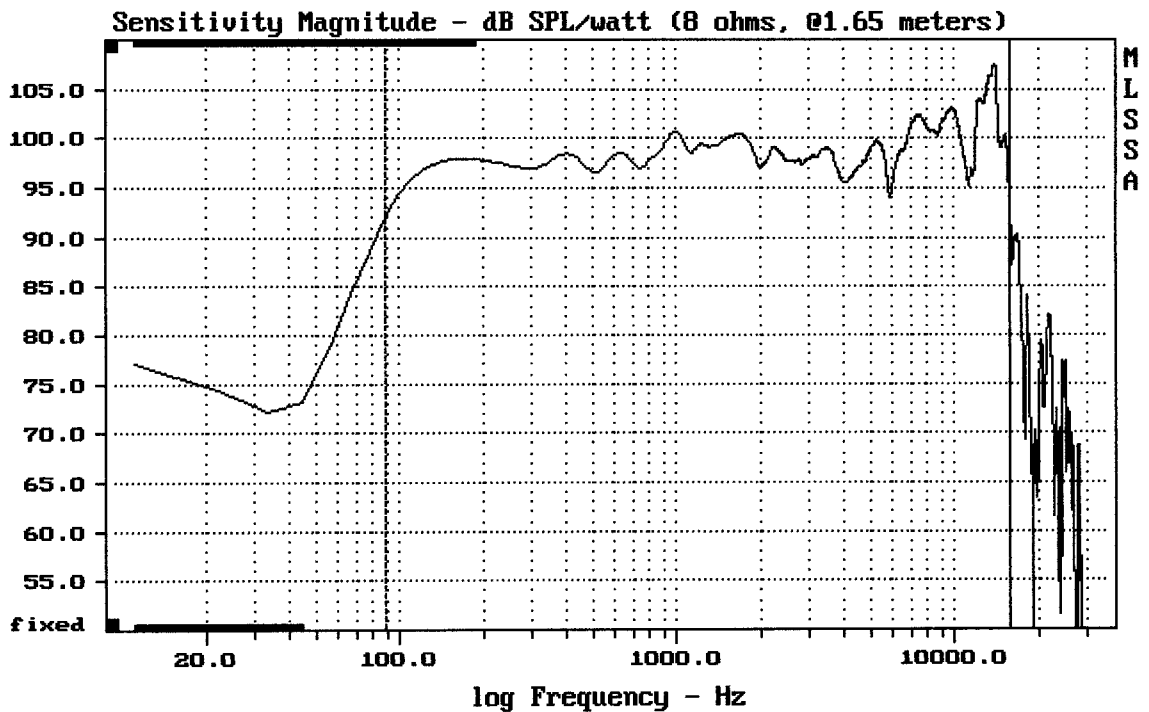

mean: 100.51, rms: 101.08, std: 2.76, max: 107.43, min: 92.00

DELTA15LF + PSD2002 + FH305

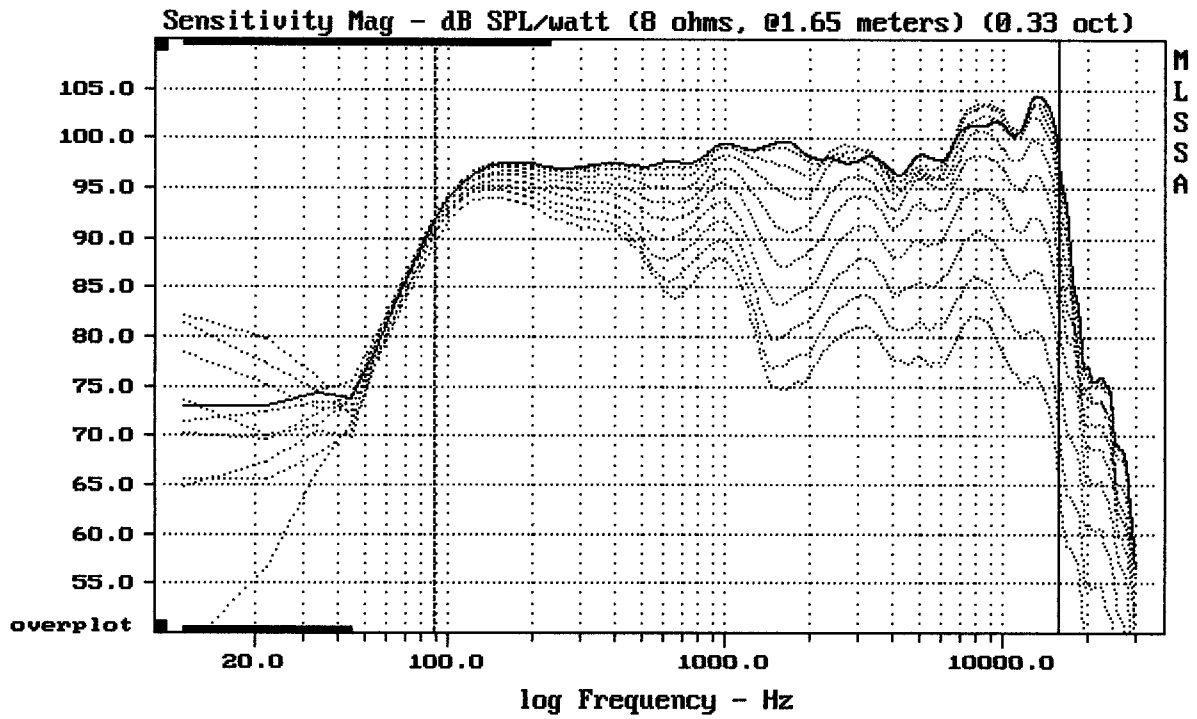

Overlay Compare: dev= +20/-10, std= 5.5, avg= -22

DELTA15LF + PSD2002 + FH305

MLSSA: Frequency Domain

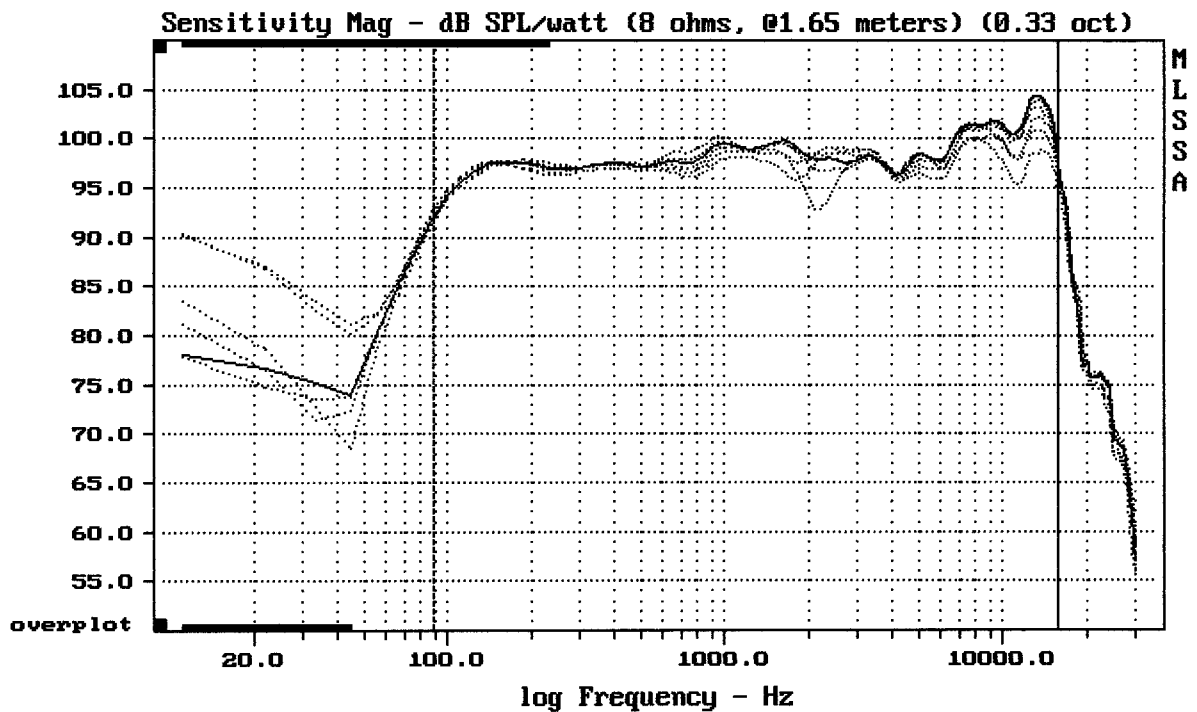

mean: 99.11, rms: 99.29, std: 1.63, max: 102.15, min: 91.82

DELTA15LF + PSD2002 + FH305

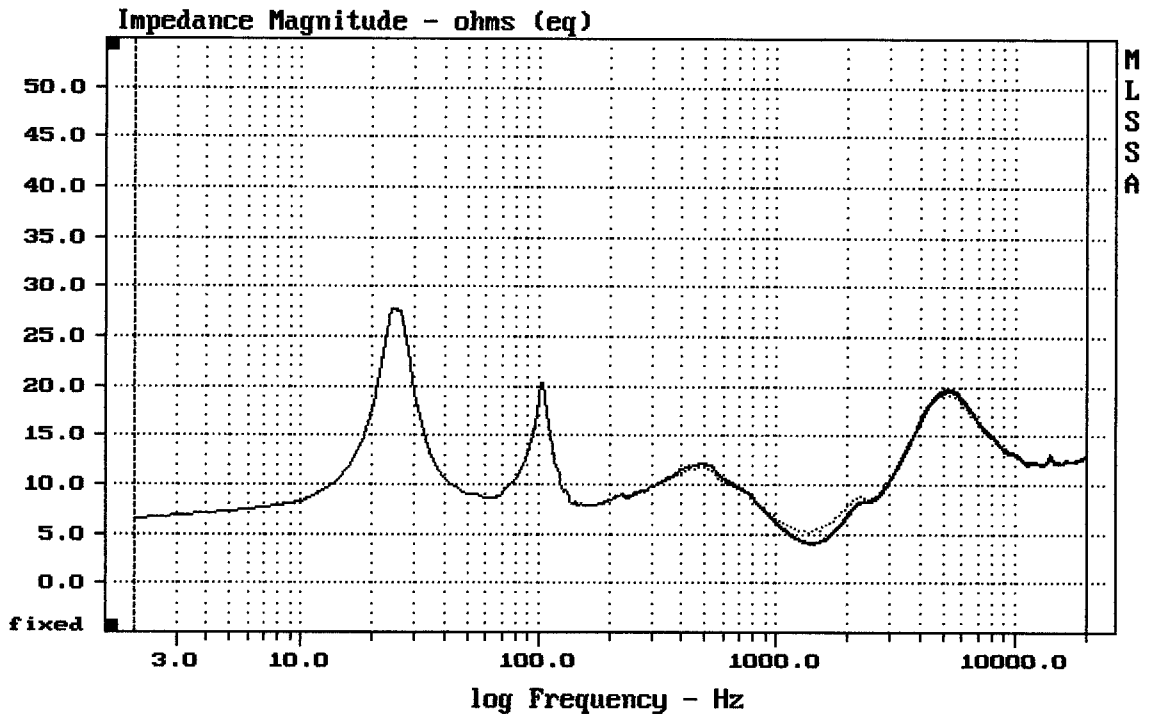

mean: 12.98, rms: 13.33, std: 3.003, max: 27.63, min: 5.194

DELTA15LF + PSD2002 + FH305

MLSSA: Frequency Domain

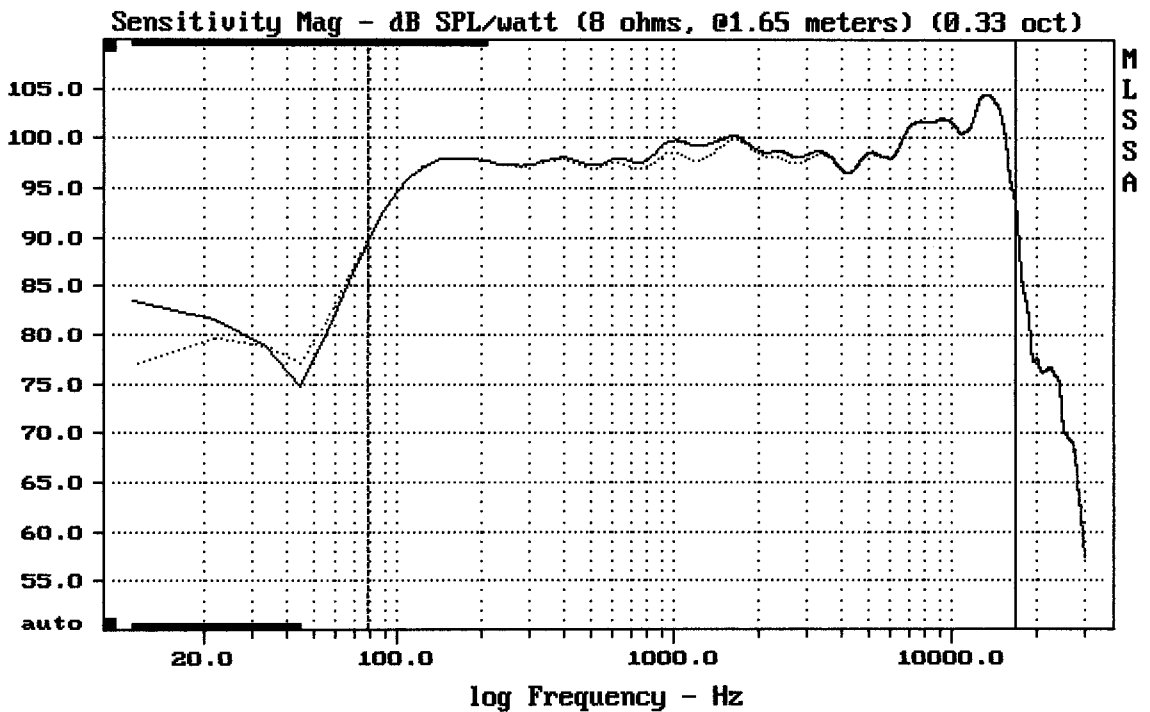

Overlay Compare: dev= +1.3/-0.3, std= 0.28, avg= 0.094

DELTA15LF + PSD2002 + FH305