

Sestava B&C Speakers 12NW76 + DE610 + Megaton B8575

Osazení:

- B&C Speakers 12NW76 8/Ohm
<http://eshop.prodance.cz/DetailPage.asp?DPG=82730>
- B&C Speakers DE610 8/Ohm
<http://eshop.prodance.cz/DetailPage.asp?DPG=82315>
- Megaton B8575
<http://eshop.prodance.cz/DetailPage.asp?DPG=84261>

Schéma výhybky:

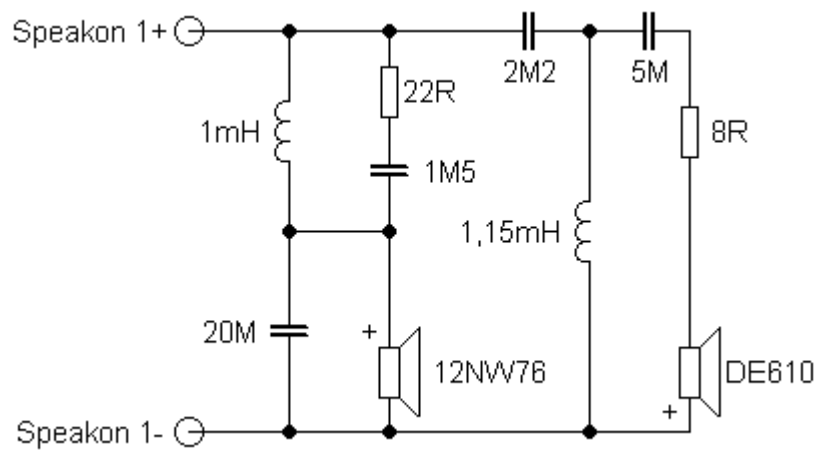

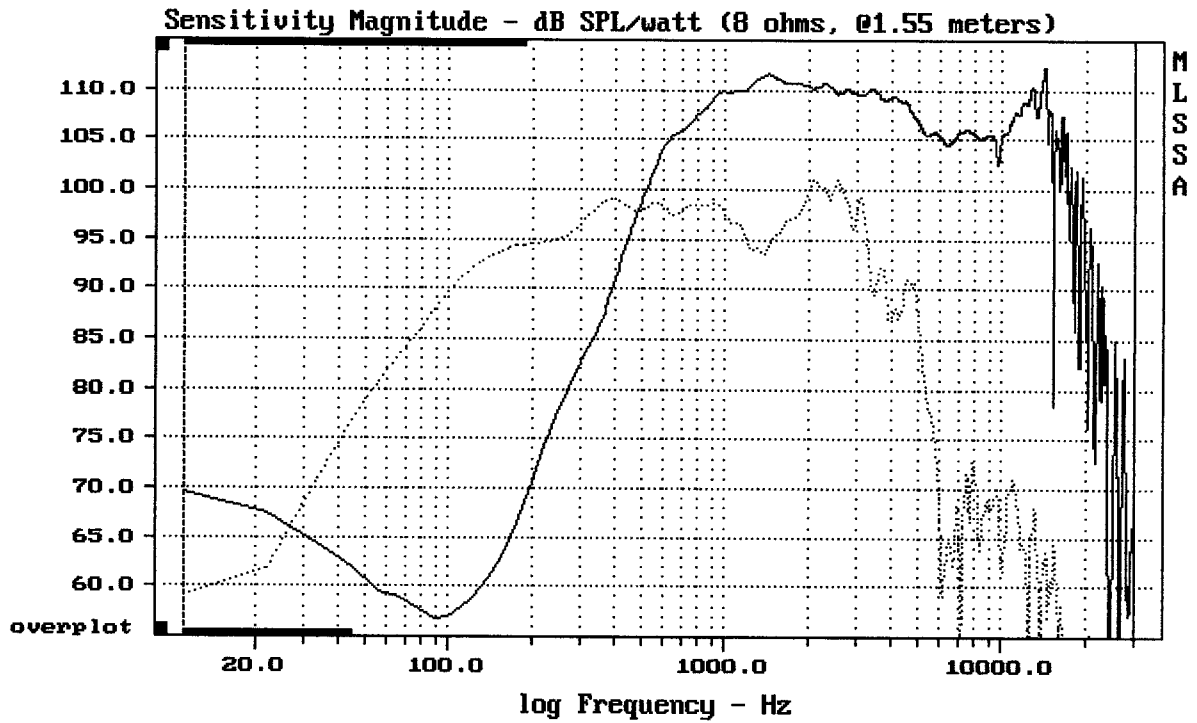

CURSOR: y = 29.1737 x = 30007.1014 (2704)

12NW76 + DE610 + B8575

MLSSA: Frequency Domain

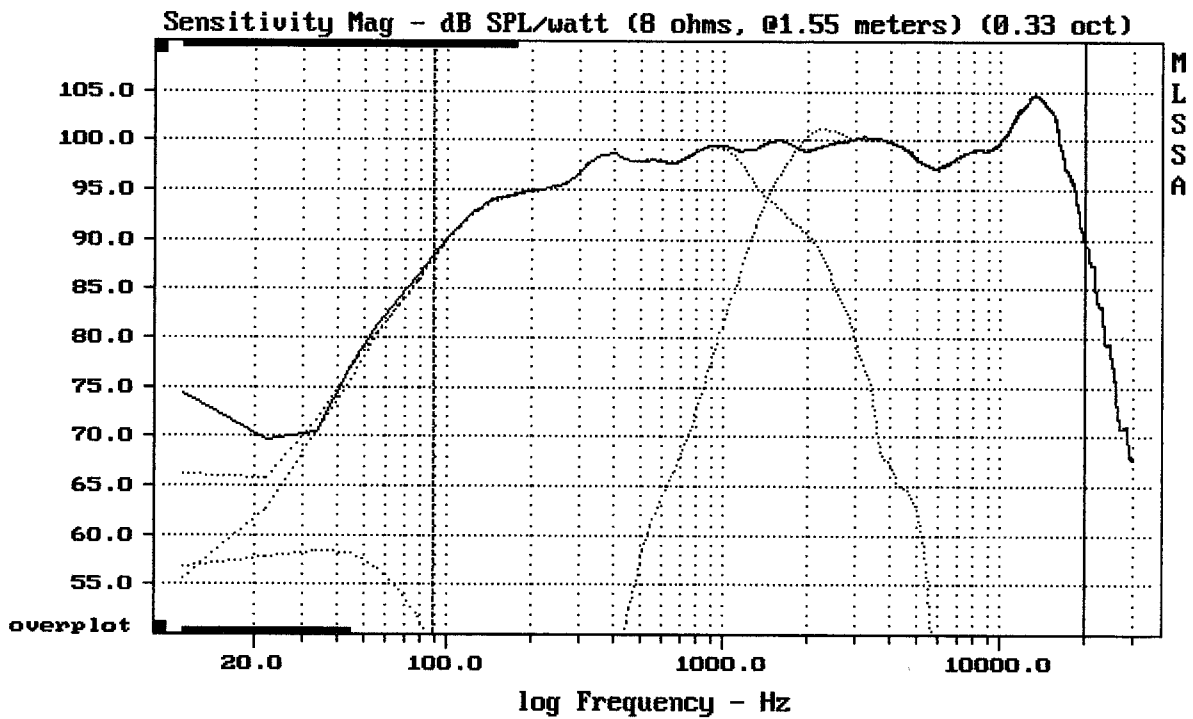

Level (89:20008 Hz) = 98.76 dB SPL/watt (8 ohms, @1.55 meters) (0.33 oct)

12NW76 + DE610 + B8575

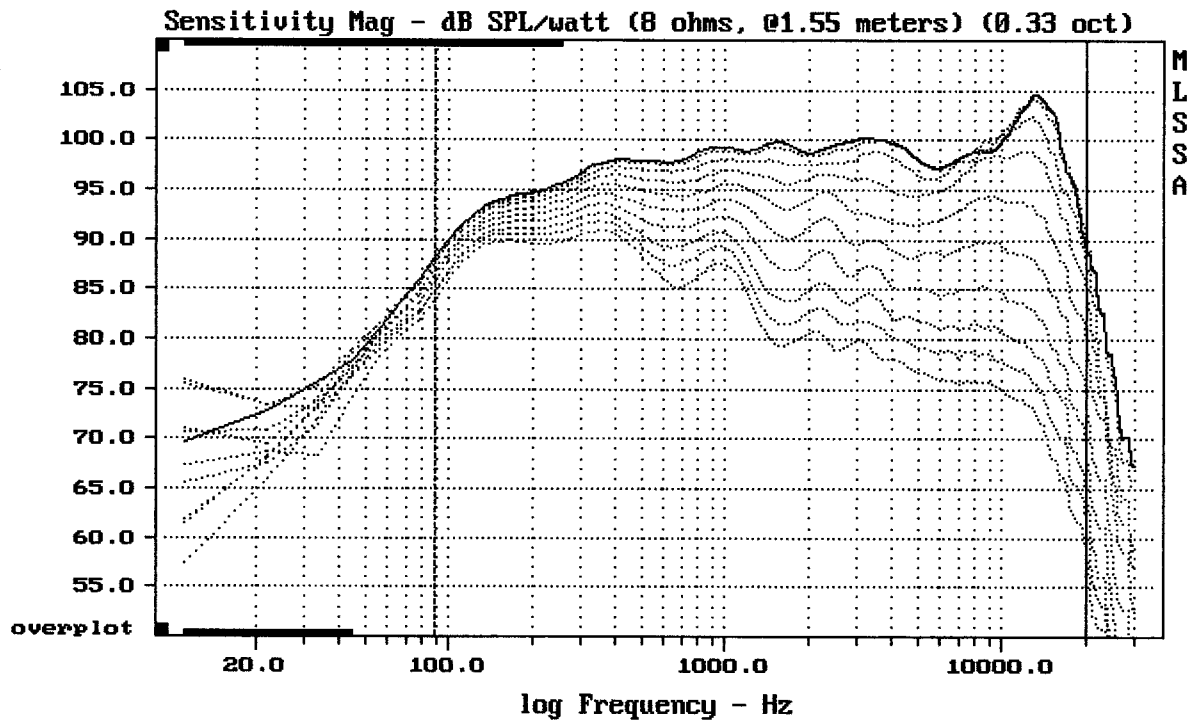

Overlay Compare: dev= +22/-8.8, std= 6.5, avg= -26

12NW76 + DE610 + B8575

MLSSA: Frequency Domain

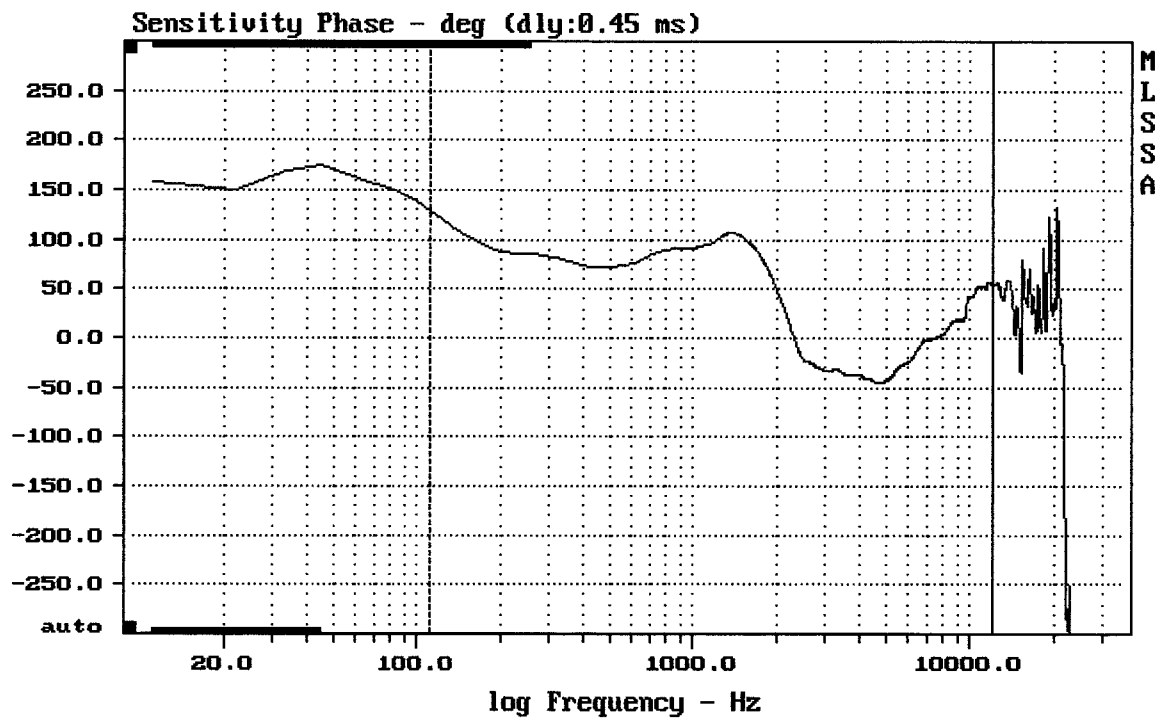

mean: 15.24, rms: 47.08, std: 44.55, max: 128.8, min: -45.64

12NW76 + DE610 + B8575

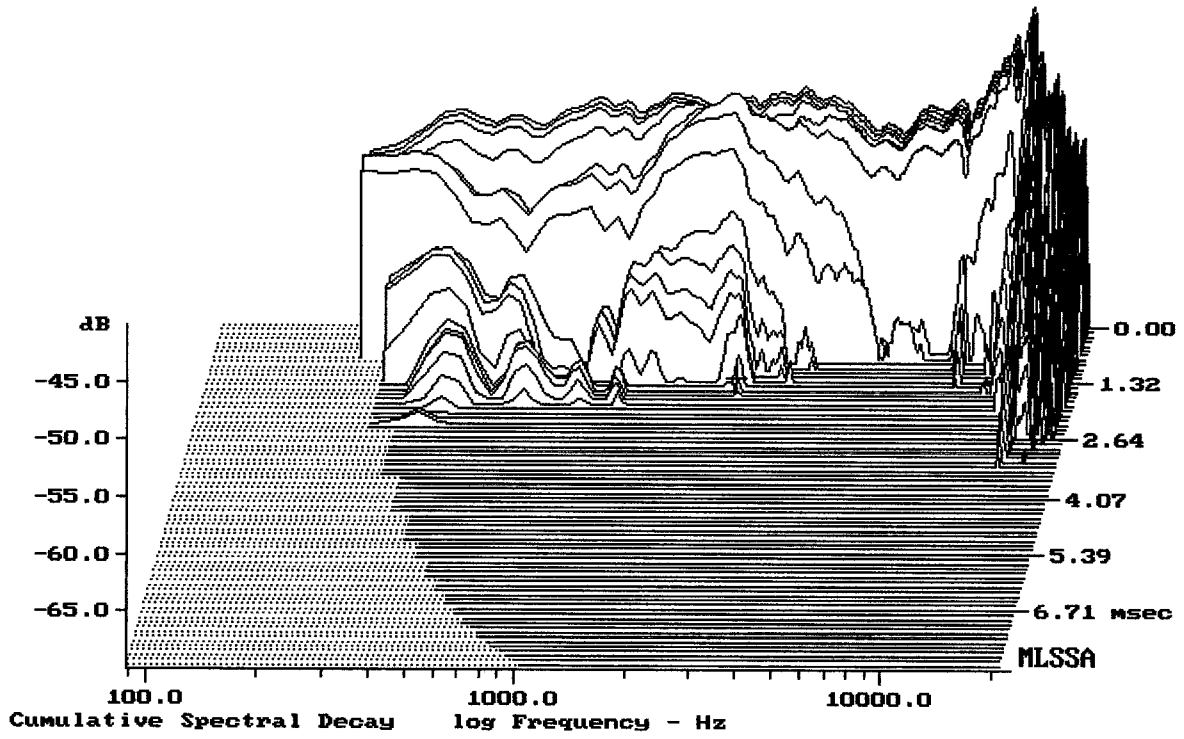

-68.80 dB, 2486 Hz (56), 1.540 msec (15)

DTTO

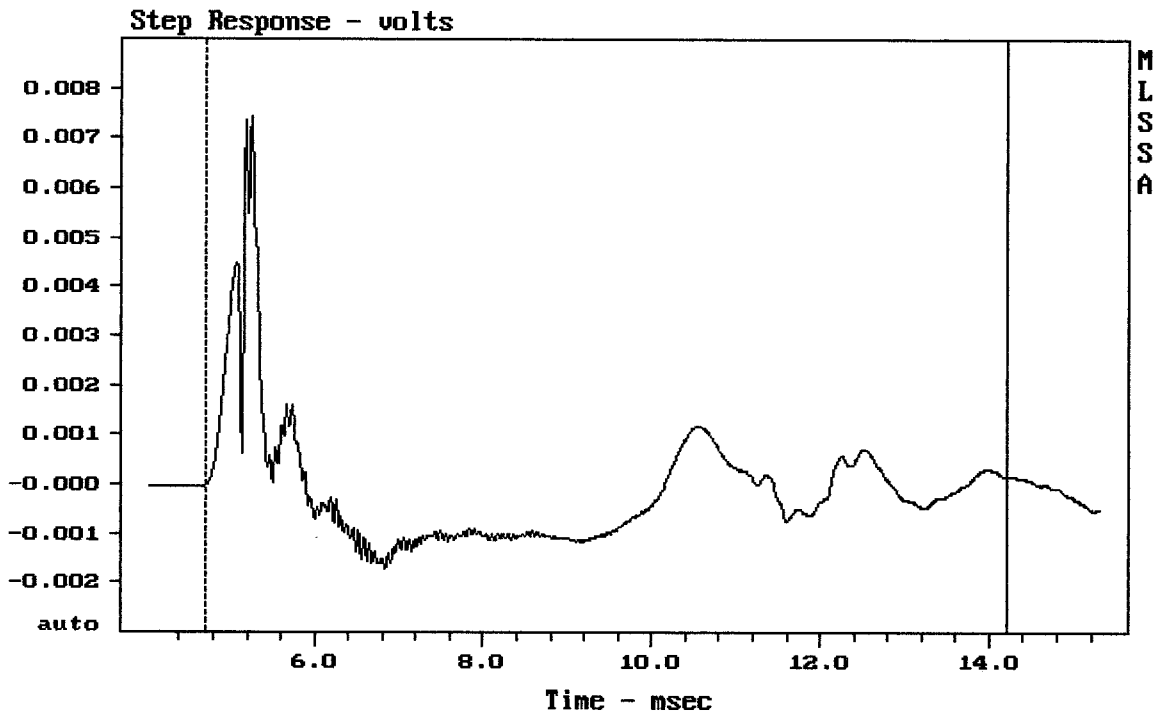

mean: -0.0001208, rms: 0.001279, std: 0.001273, max: 0.007439, min: -0.001725

12NW76 + DE610 + B8575