

Sestava B&C Speakers 12PLB76 + DE200 + Megaton A7570u

Osazení:

- B&C Speakers 12PLB76 8/Ohm

<http://eshop.prodance.cz/DetailPage.asp?DPG=82746>

- B&C Speakers DE200 8/Ohm

<http://eshop.prodance.cz/DetailPage.asp?DPG=82302>

- Megaton A7570u

<http://eshop.prodance.cz/DetailPage.asp?DPG=83913>

Schéma výhybky:

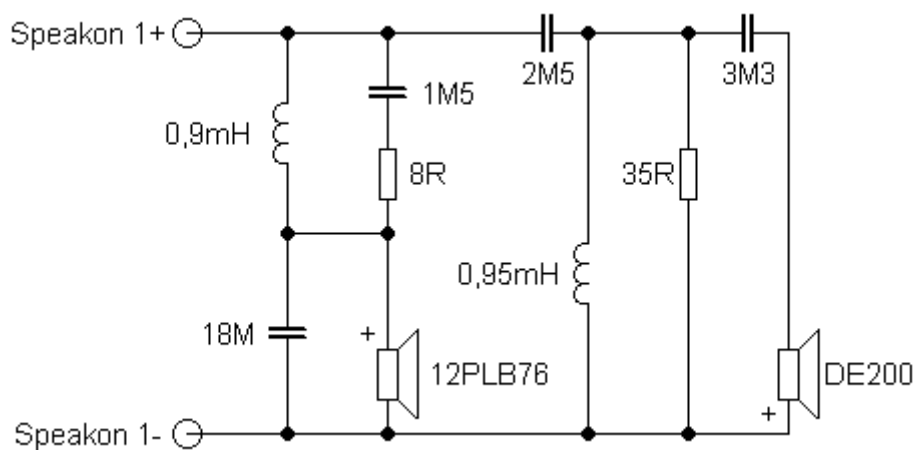

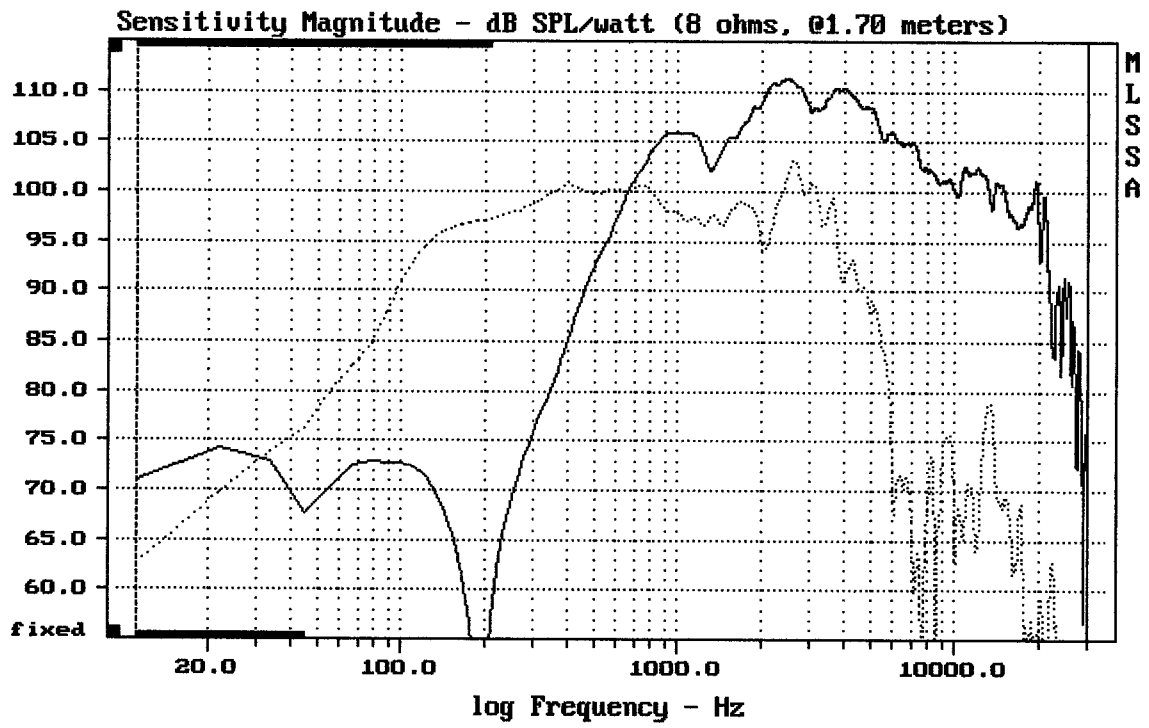

CURSOR: dy = -35.5012 x = 30007.1014 (2704)

12PLB76 + DE200 + A7570u

MLSSA: Frequency Domain

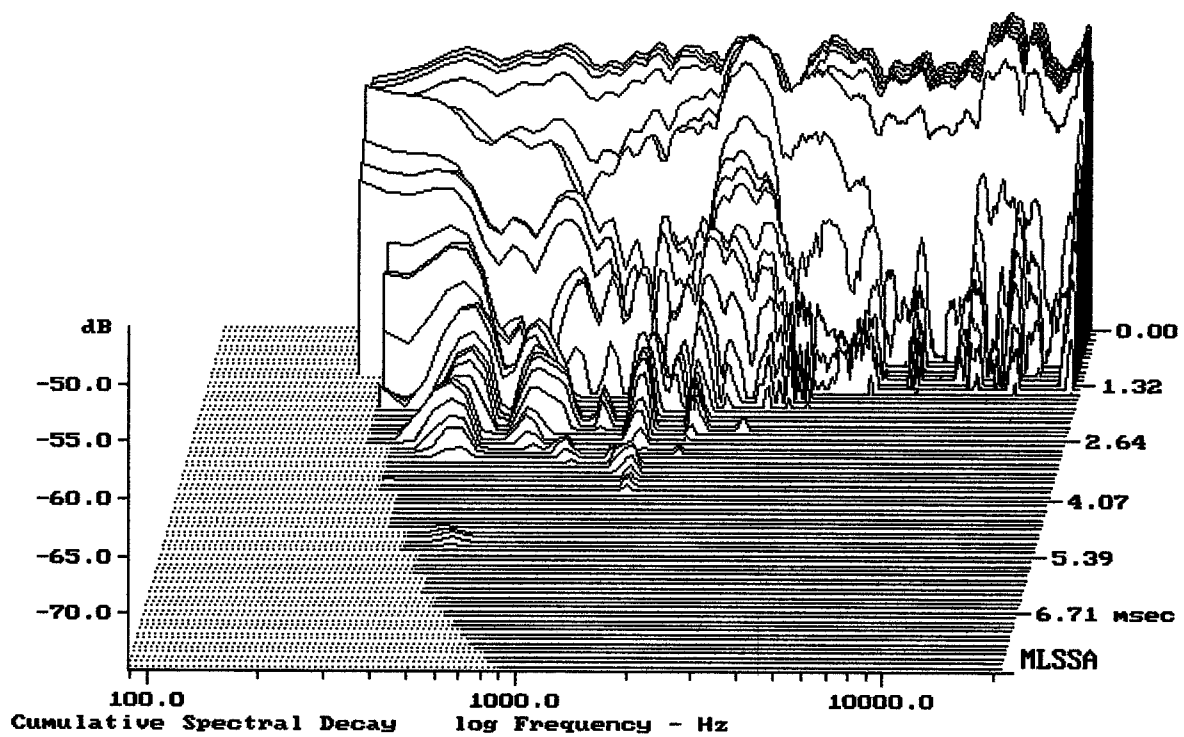

-72.04 dB, 1998 Hz (45), 2.420 msec (23)

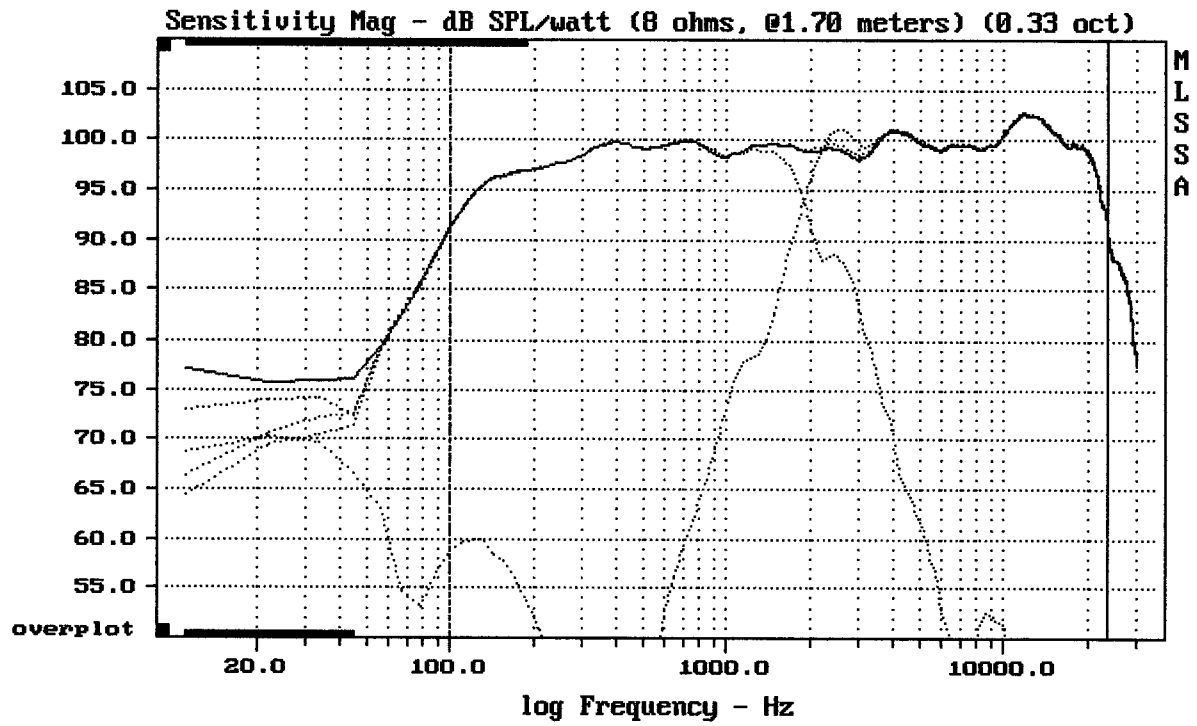

Level (100:23504 Hz) = 99.22 dB SPL/watt (8 ohms, @1.70 meters) (0.33 oct)

12PLB76 + DE200 + A7570u

MLSSA: Frequency Domain

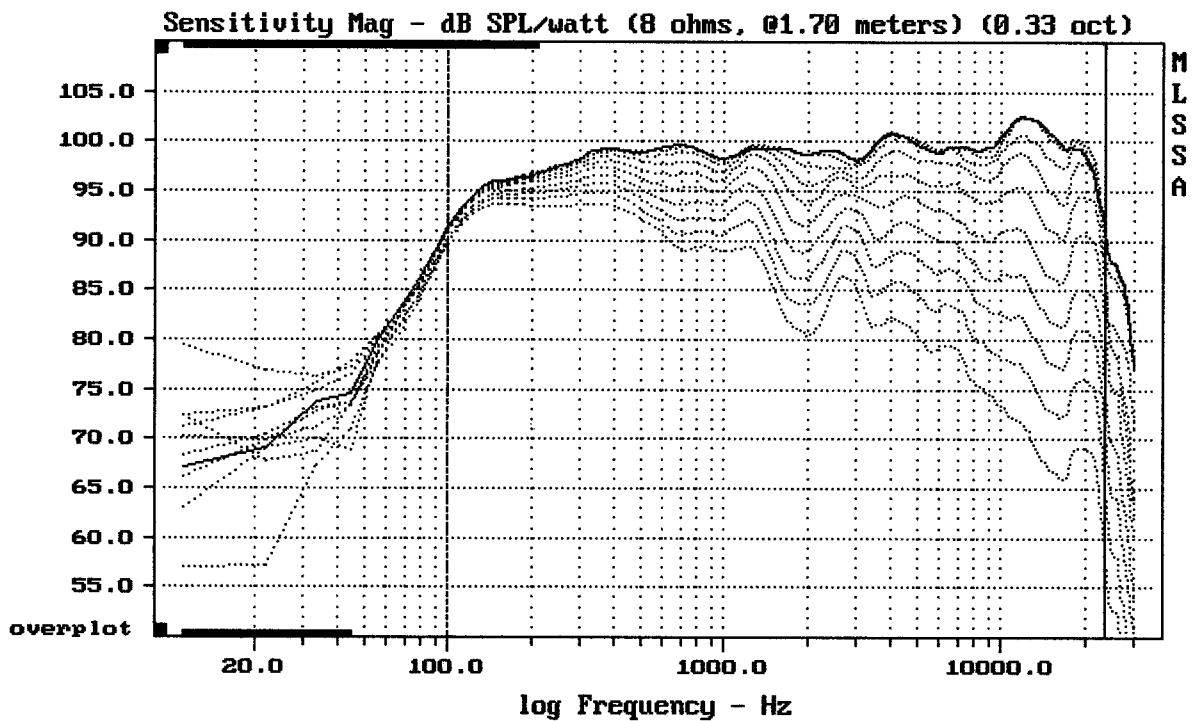

Overlay Compare: dev= +24/-8, std= 7.3, avg= -26

12PLB76 + DE200 + A7570u

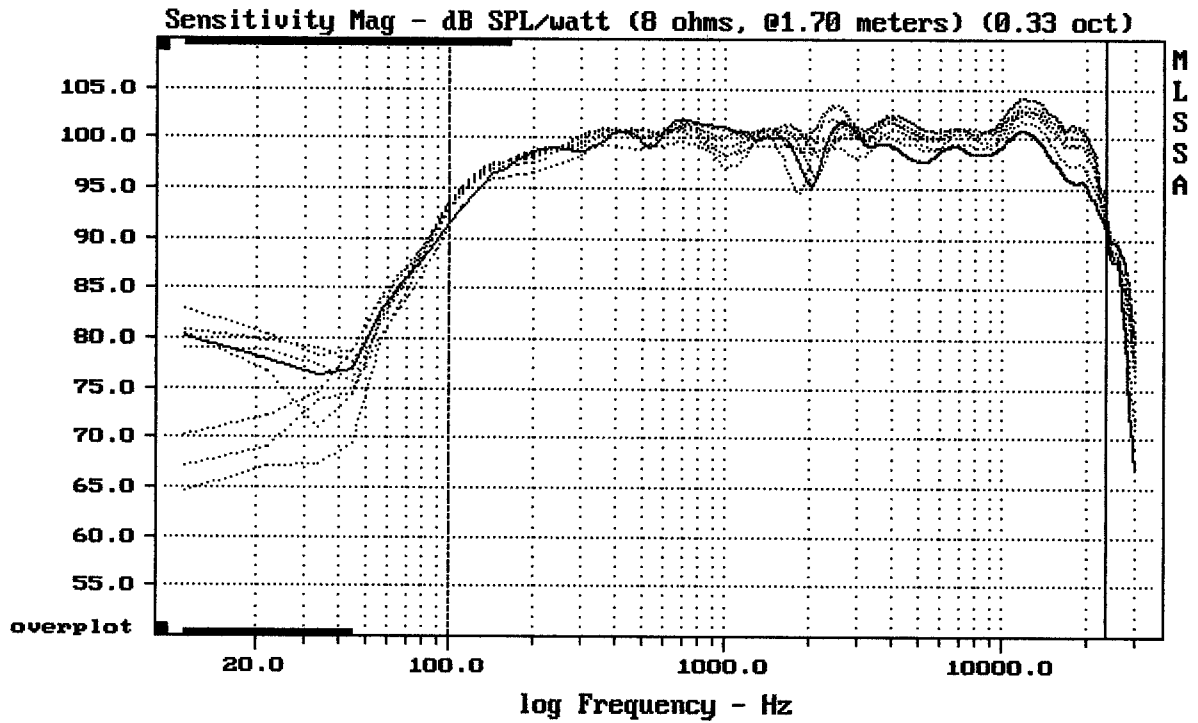

mean: 100.73, rms: 100.91, std: 1.62, max: 103.45, min: 92.83

12PLB76 + DE200 + A7570u

MLSSA: Frequency Domain

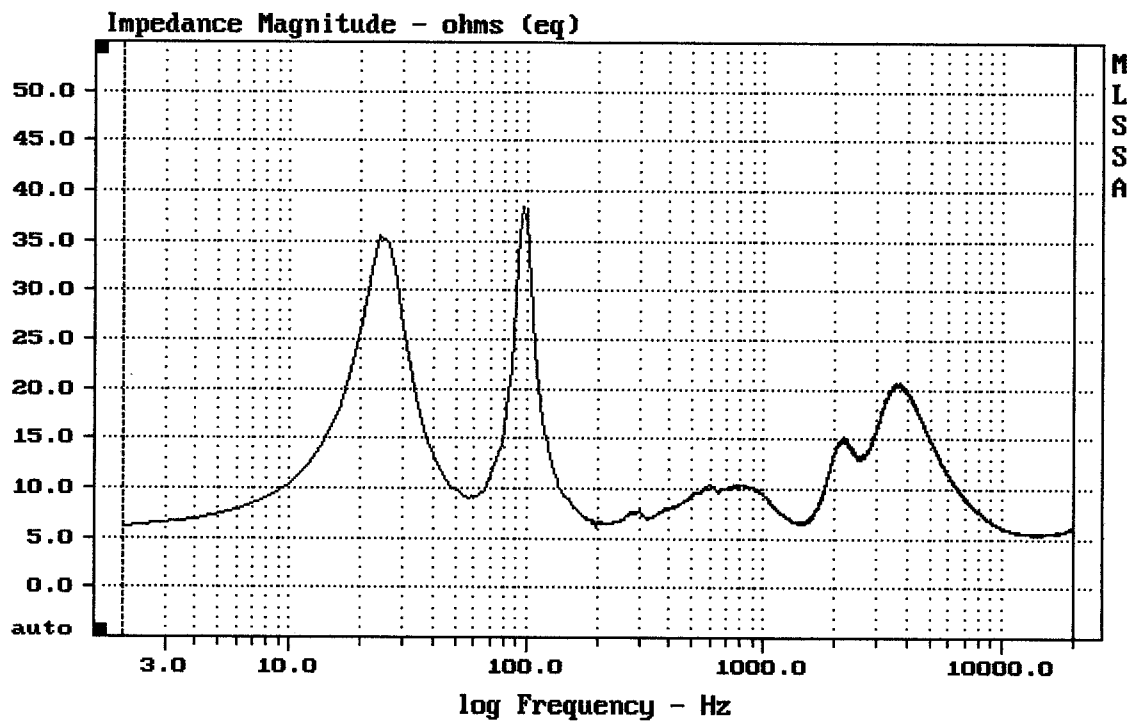

mean: 8.56, rms: 9.599, std: 4.343, max: 38.42, min: 5.391

12PLB76 + DE200 + A7570u