

Sestava B&C Speakers 12PZ32 + DE200 + Megaton A7570u

Osazení:

- B&C Speakers 12PZ32 8/Ohm
<http://eshop.prodance.cz/DetailPage.asp?DPG=82769>
- B&C Speakers DE200 8/Ohm
<http://eshop.prodance.cz/DetailPage.asp?DPG=82302>
- Megaton A7570u
<http://eshop.prodance.cz/DetailPage.asp?DPG=83913>

Schéma výhybky:

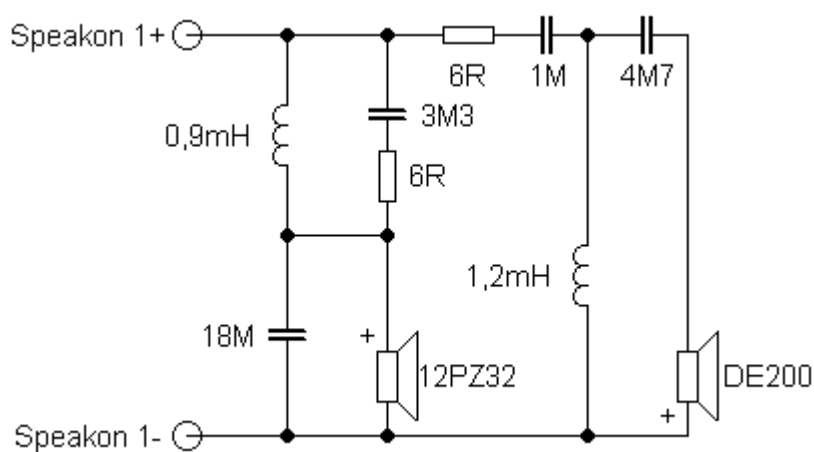

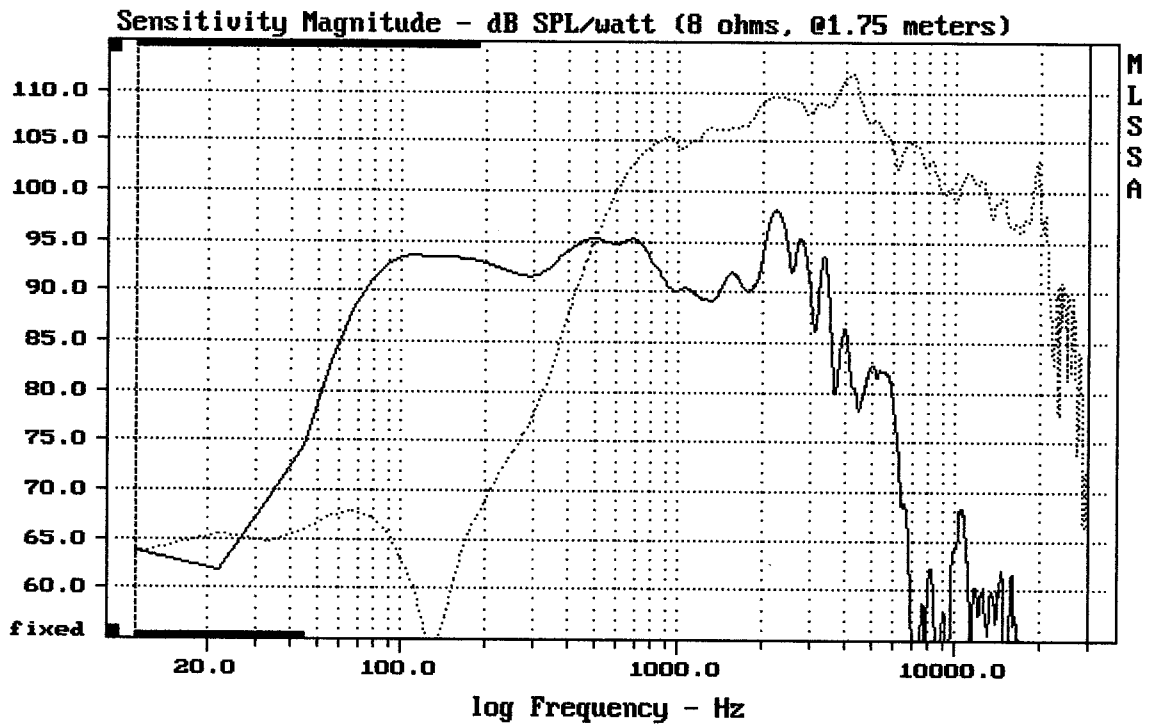

CURSOR: dy = 31.6603 x = 30007.1014 (2704)

12PZ32 + DE200 + A7570u

MLSSA: Frequency Domain

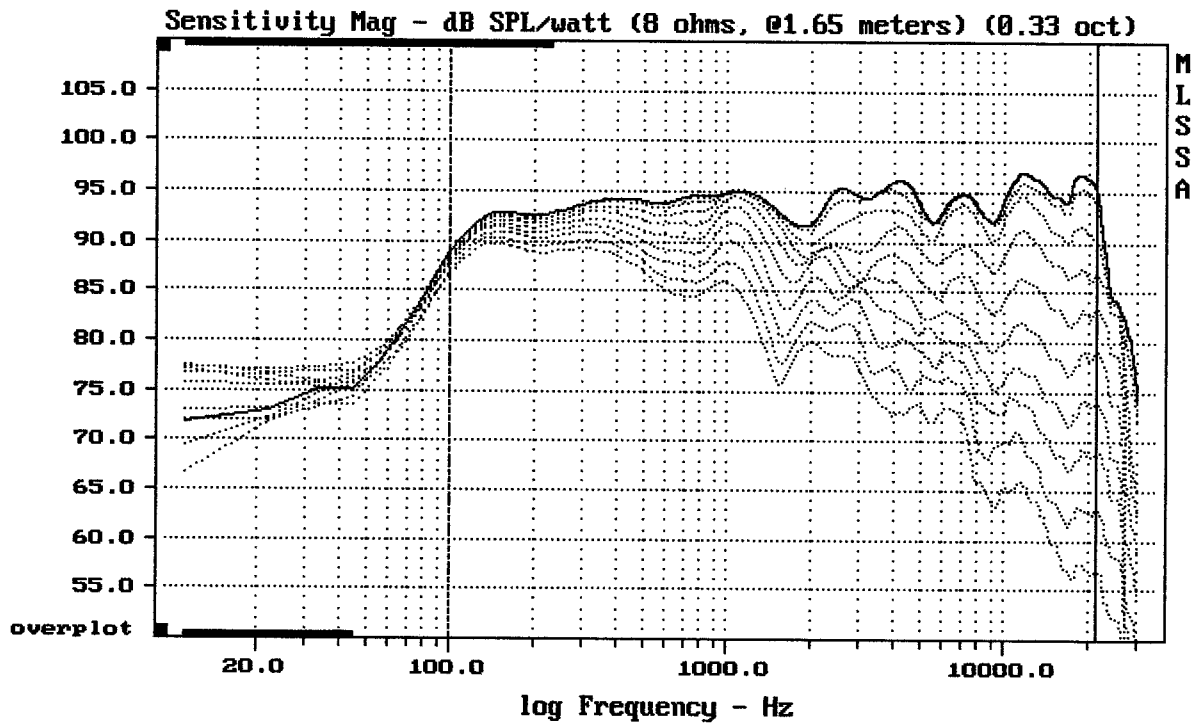

Overlay Compare: dev= +26/-12, std= 9.1, avg= -29

12PZ32 + DE200 + A7570u

MLSSA: Frequency Domain

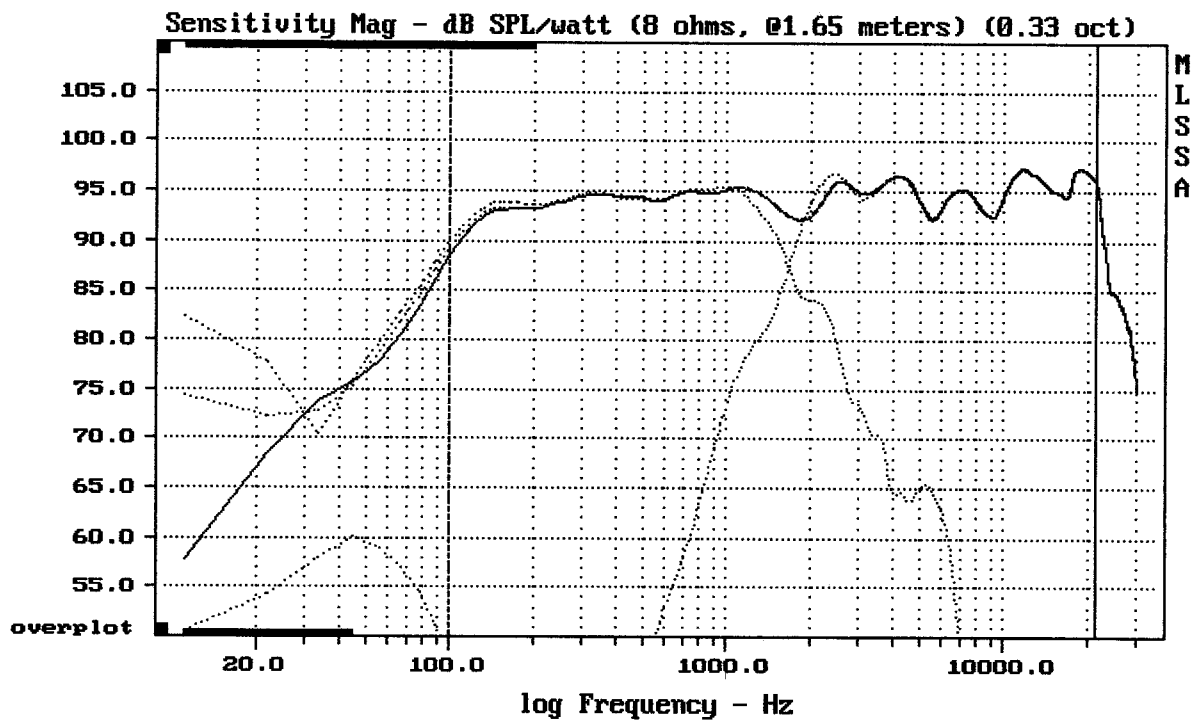

Level (100:21507 Hz) = 94.59 dB SPL/watt (8 ohms, @1.65 meters) (0.33 oct)

12PZ32 + DE200 + A7570u

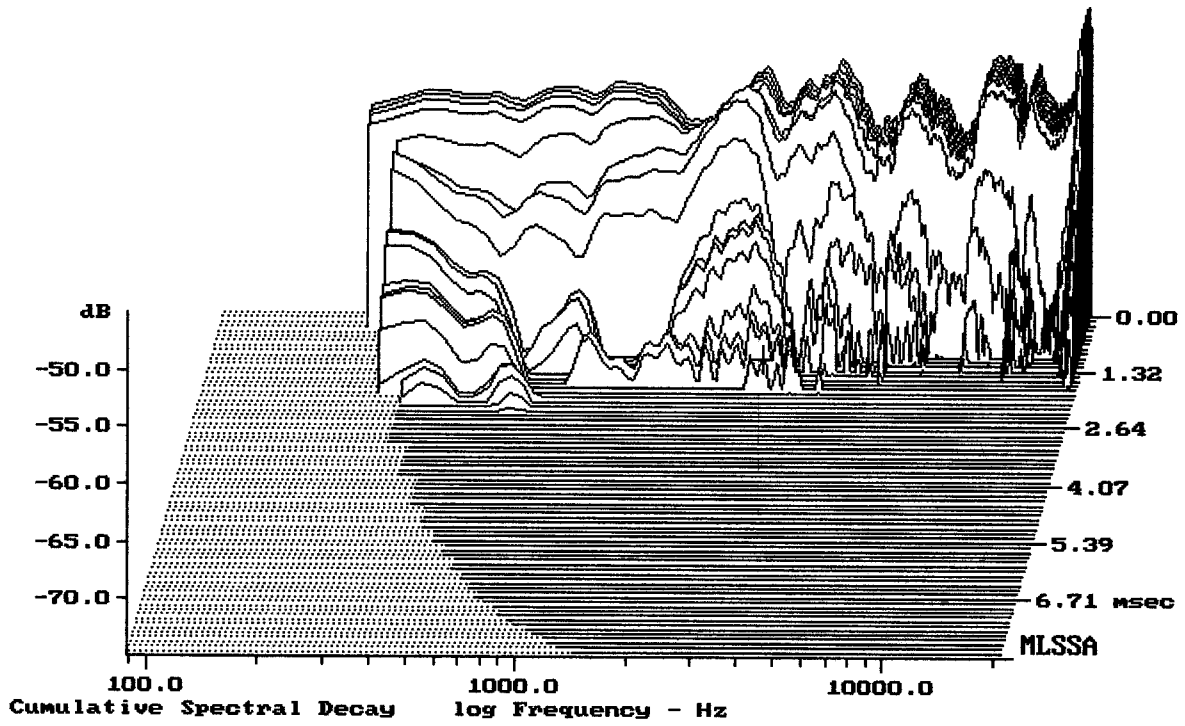

-72.43 dB, 2930 Hz (66), 1.760 msec (17)

DTTO

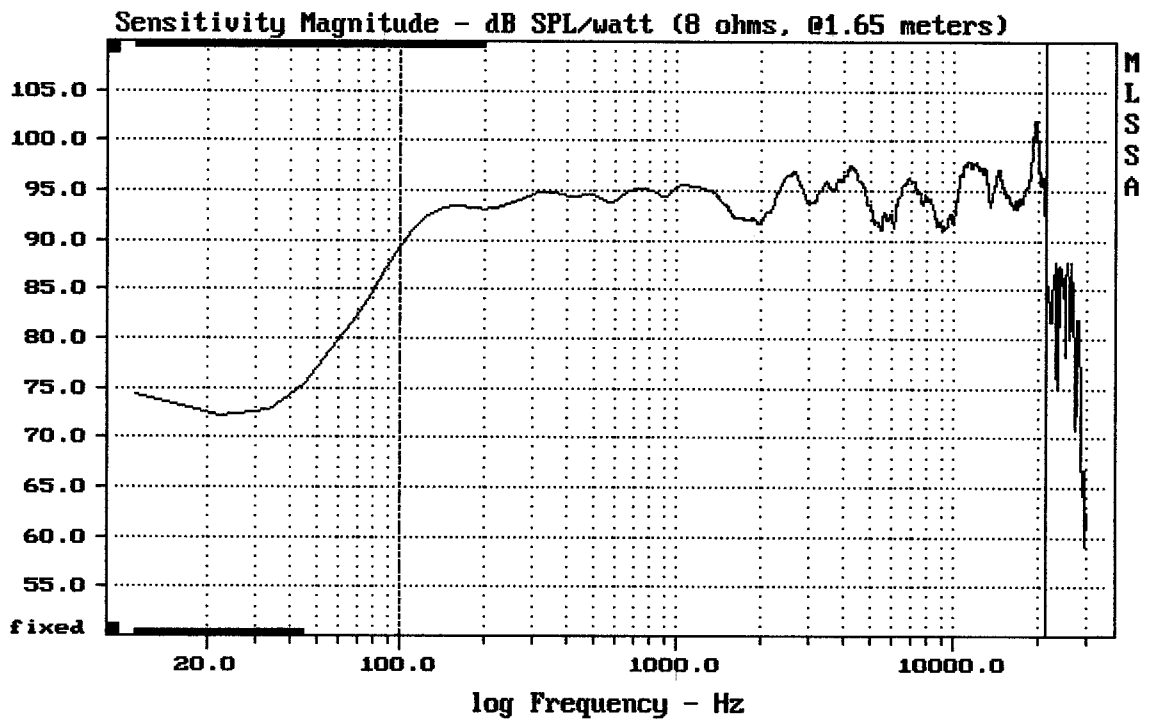

Level (100:21507 Hz) = 94.64 dB SPL/watt (8 ohms, @1.65 meters)

12P232 + DE200 + A7570u

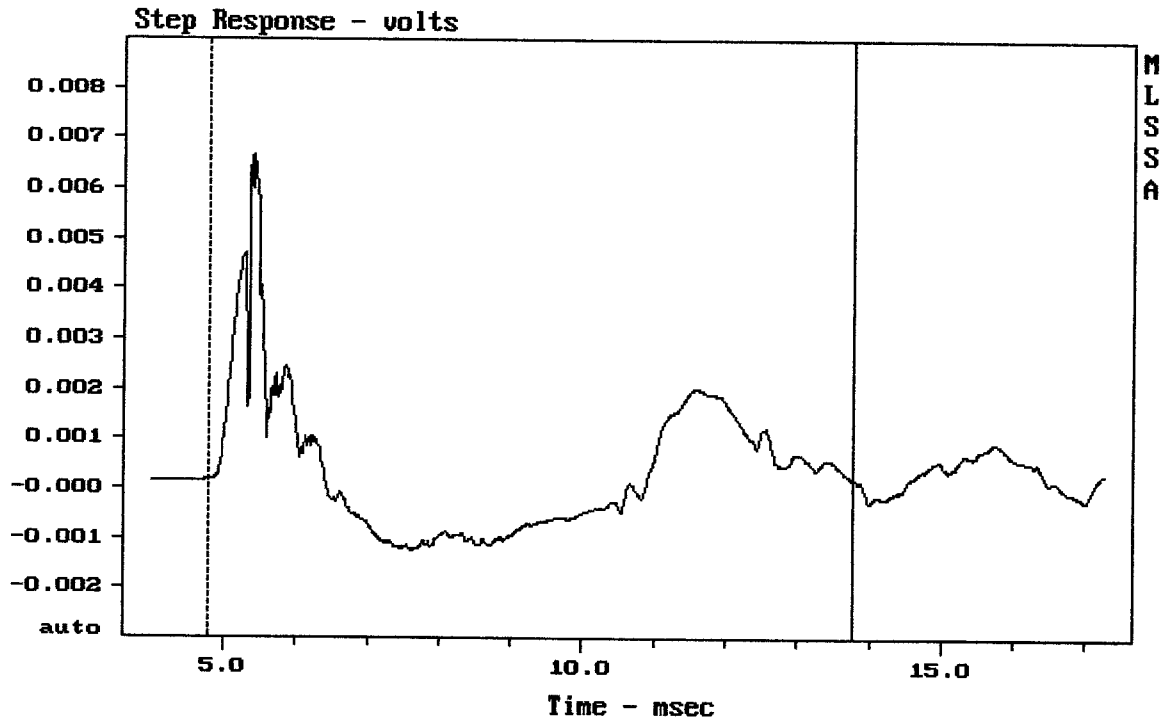

mean: 0.0003708, rms: 0.001457, std: 0.001409, max: 0.00665, min: -0.001239

12P232 + DE200 + A7570u

MLSSA: Time Domain

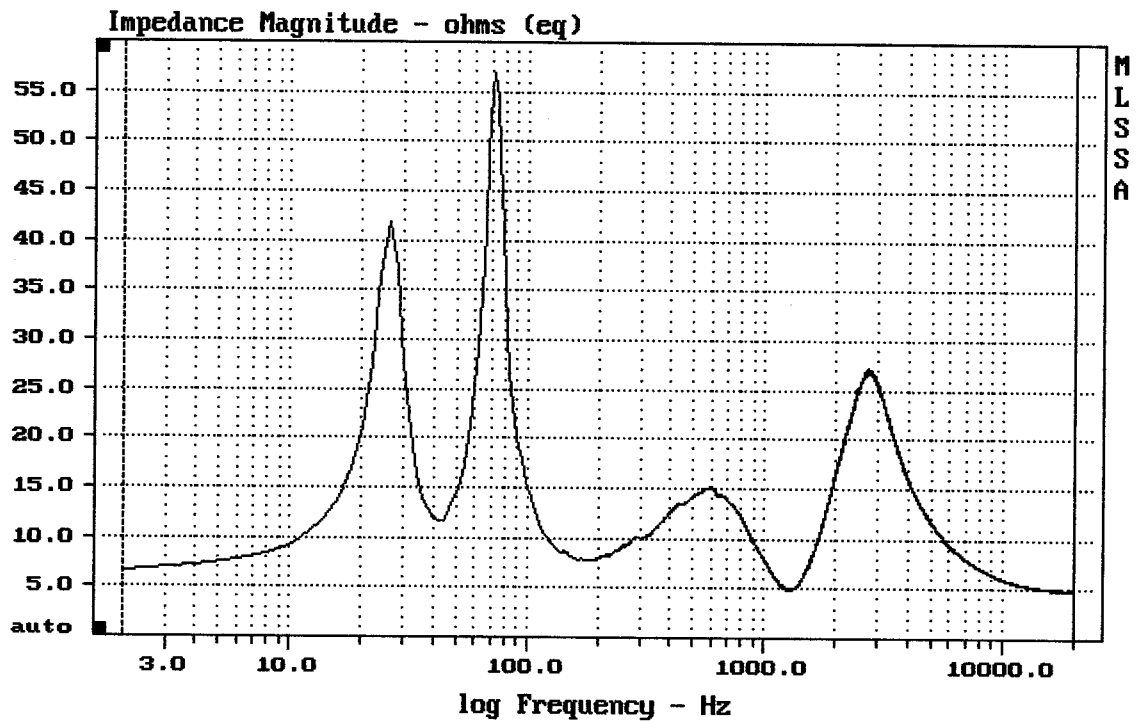

mean: 8.548, rms: 10.18, std: 5.532, max: 56.86, min: 4.853

12P232 + DE200 + A7570u