

Sestava B&C Speakers 12HPL76 + DE500 + Megaton A7570u

Osazení:

- B&C Speakers 12HPL76 8/Ohm
<http://eshop.prodance.cz/DetailPage.asp?DPG=82710>
- B&C Speakers DE500 8/Ohm
<http://eshop.prodance.cz/DetailPage.asp?DPG=82312>
- Megaton A7570u
<http://eshop.prodance.cz/DetailPage.asp?DPG=83913>

Schéma výhybky:

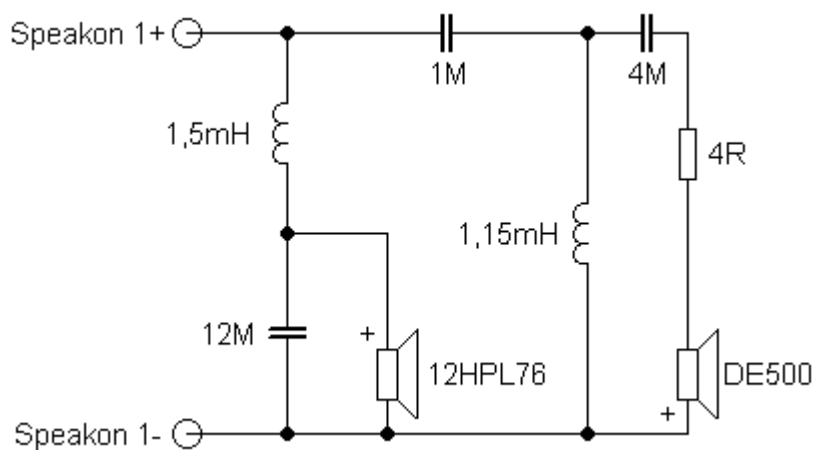

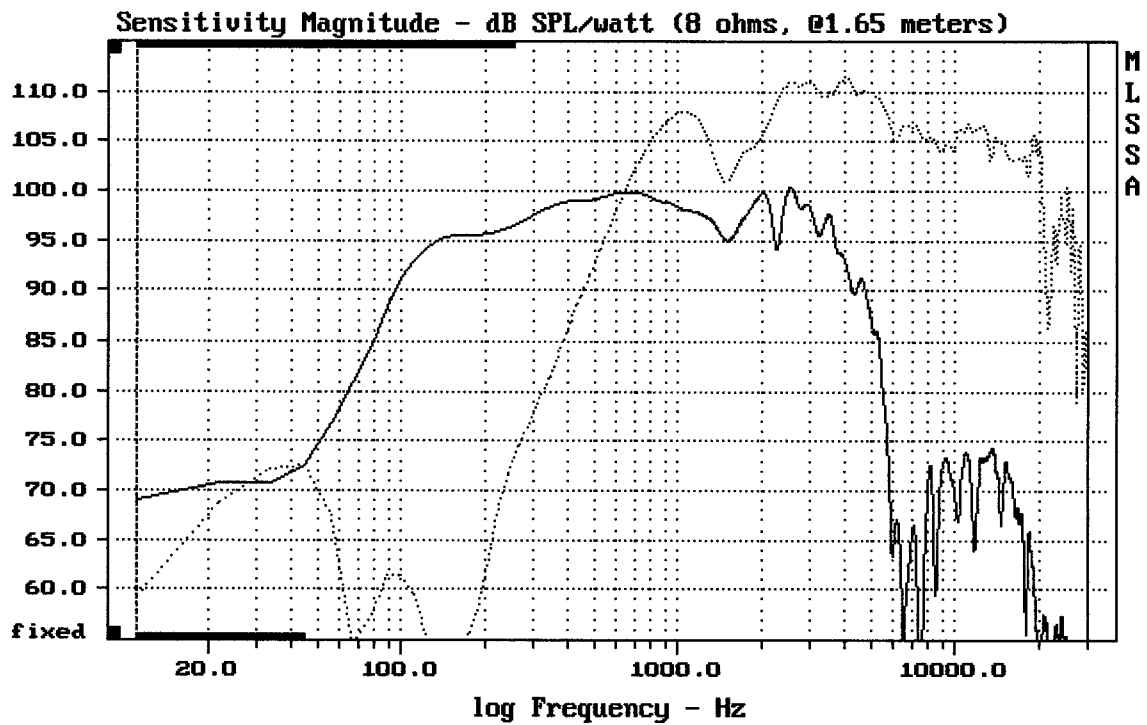

CURSOR: dy = 37.2117 x = 30007.1014 (2704)

12HPL76 + DE500 + A7570u

MLSSA: Frequency Domain

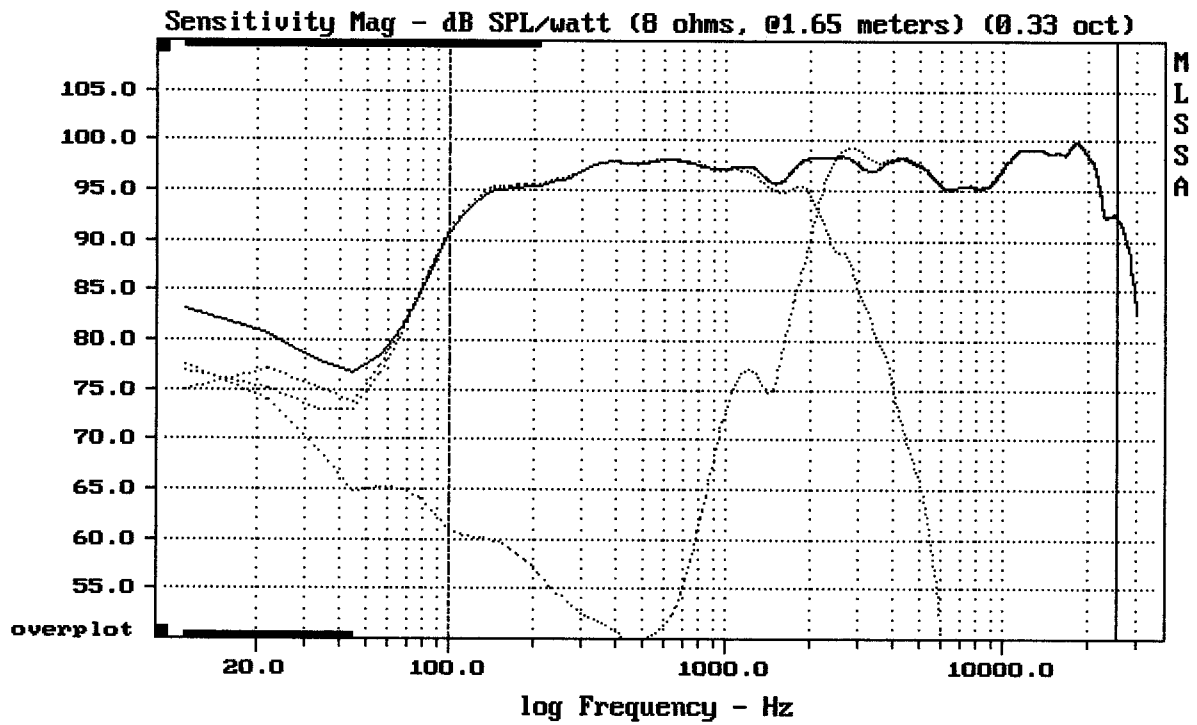

Level (100:25502 Hz) = 97.12 dB SPL/watt (8 ohms, @1.65 meters) (0.33 oct)

12HPL76 + DE500 + A7570u

MLSSA: Frequency Domain

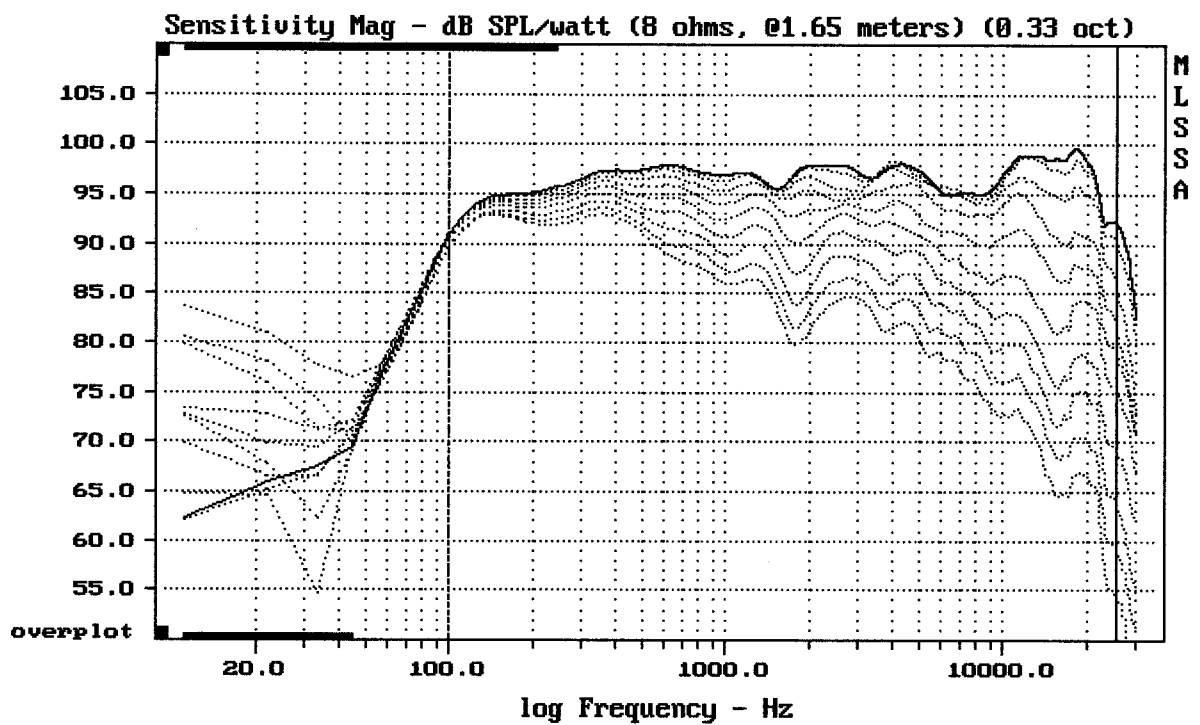

Overlay Compare: dev= +25/-12, std= 8.5, avg= -26

12HPL76 + DE500 + A7570u

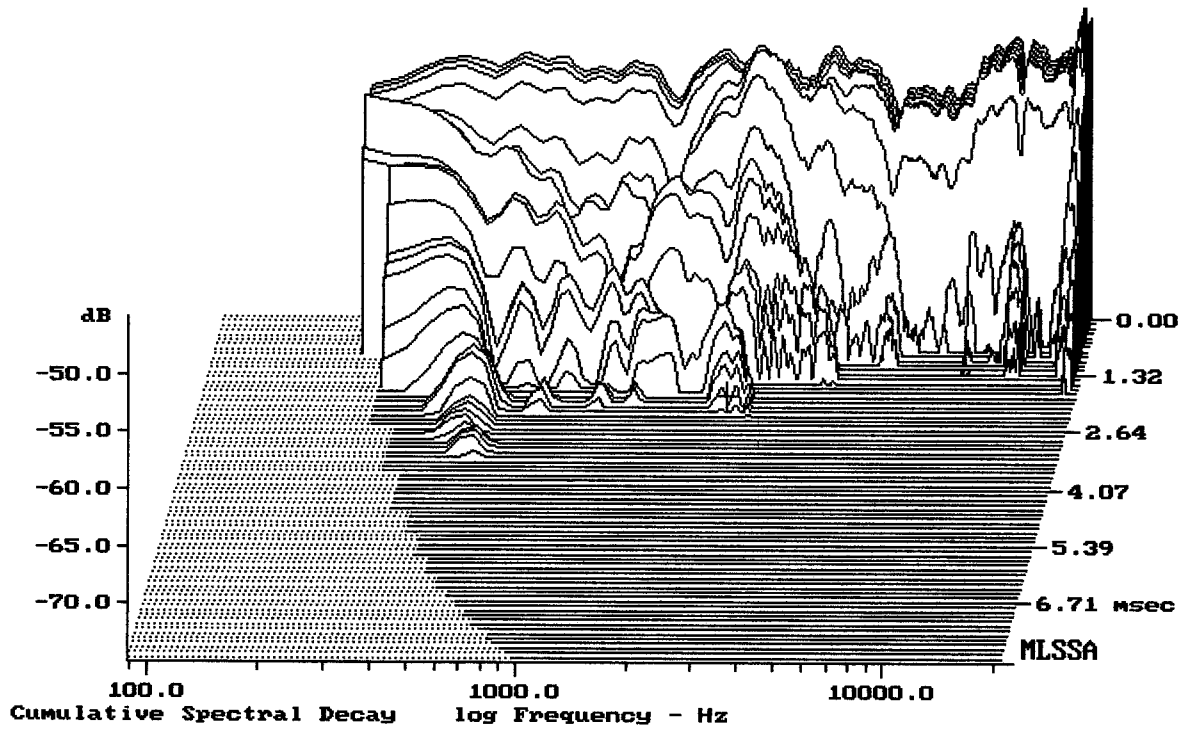

-74.07 dB, 2397 Hz (54), 2.090 msec (20)

DLTO

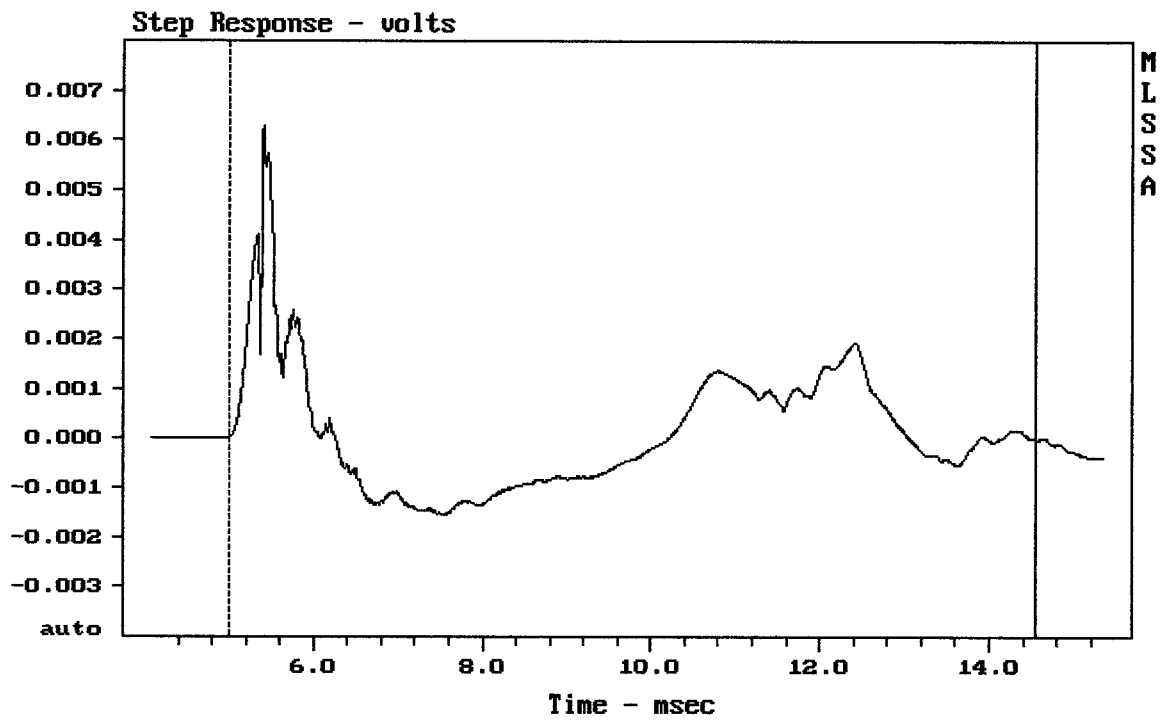

mean: 0.0001206, rms: 0.001258, std: 0.001252, max: 0.006292, min: -0.001557

12HPL76 + DE500 + A7570u

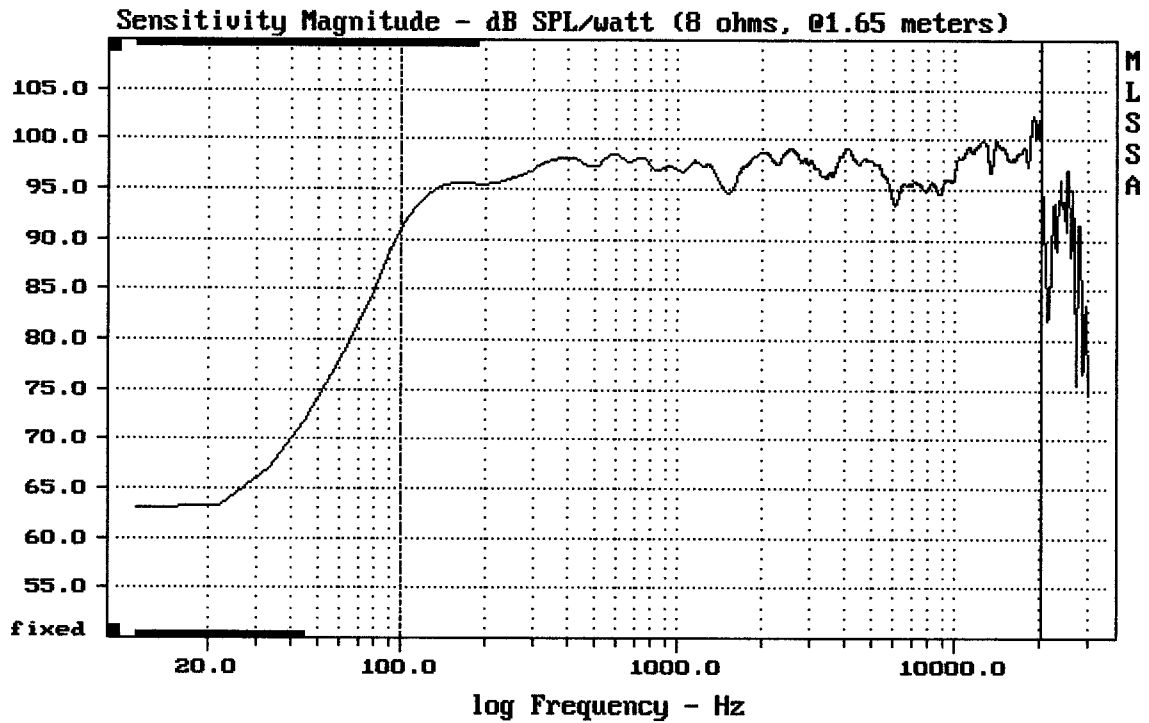

Level (100:20500 Hz) = 97.27 dB SPL/watt (8 ohms, @1.65 meters)

12HPL76 + DE500 + A7570u

MLSSA: Frequency Domain

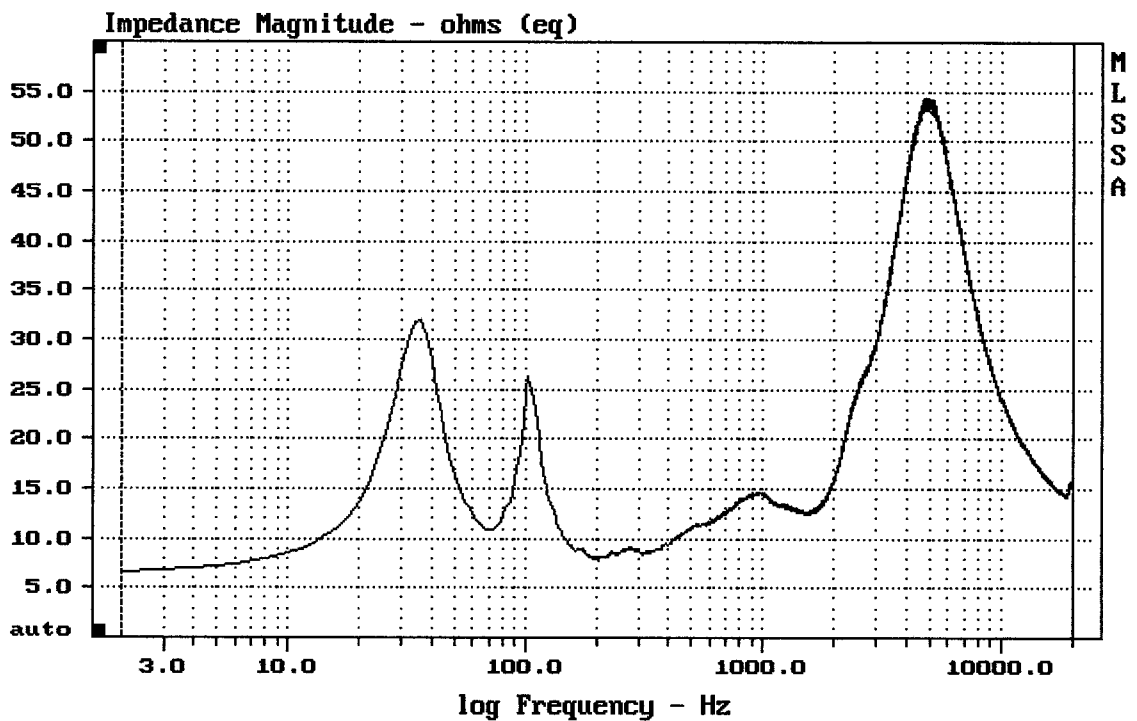

mean: 24.88, rms: 27.76, std: 12.31, max: 54.38, min: 6.587

12HPL76 + DE500 + A7570u