

Sestava 2x B&C Speakers 12PE32 + DE82TN + Megaton B8575

Osazení:

- 2x B&C Speakers 12PE32 8/Ohm
<http://eshop.prodance.cz/DetailPage.asp?DPG=82733>
- B&C Speakers DE82TN 8/Ohm
<http://eshop.prodance.cz/DetailPage.asp?DPG=92772>
- Megaton B8575
<http://eshop.prodance.cz/DetailPage.asp?DPG=84261>

Schéma výhybky:

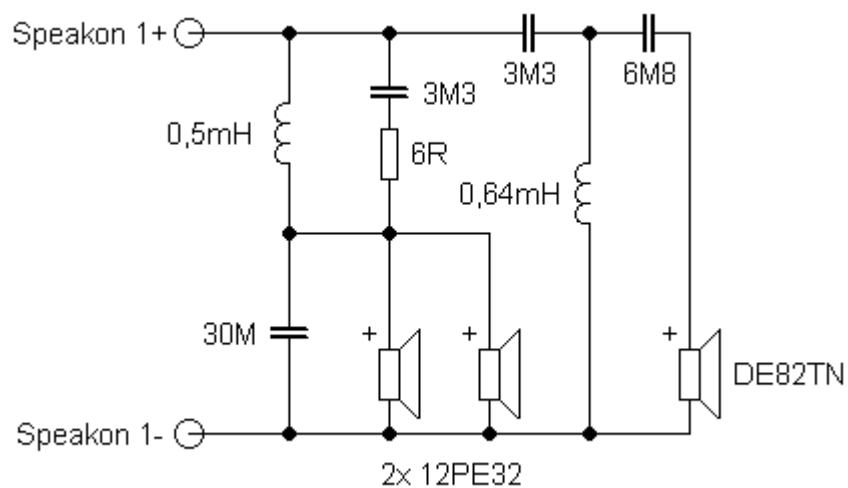

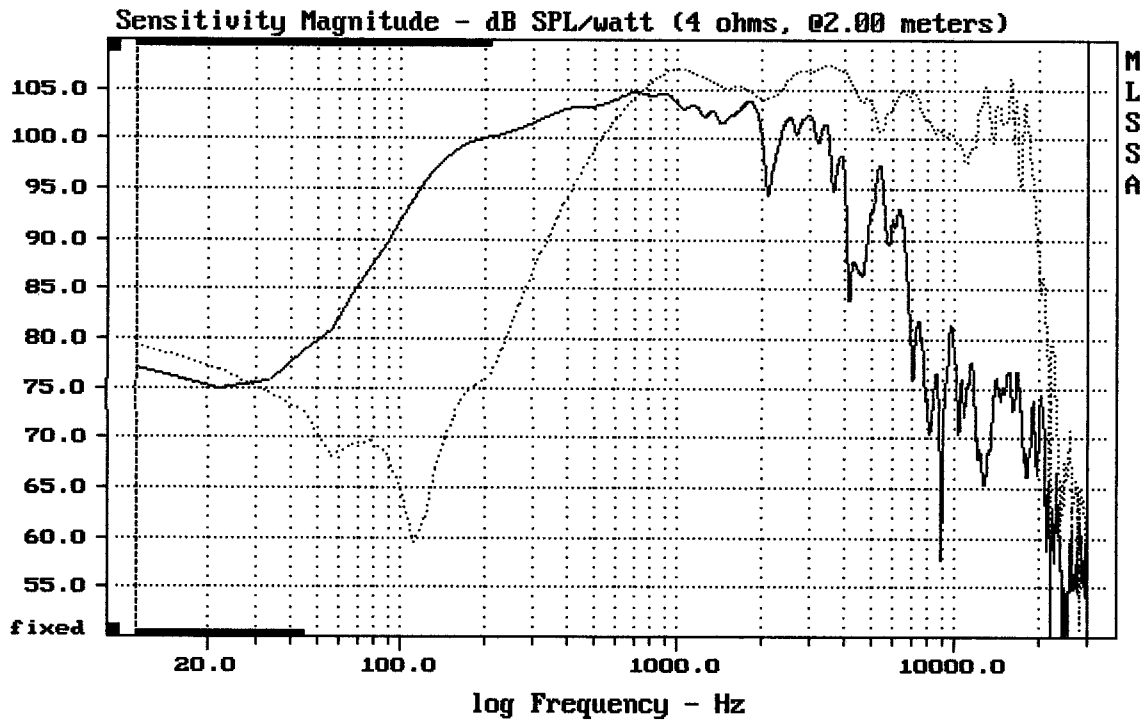

CURSOR: dy = 0.848892 x = 30007.1014 (2704)

2x12PE32 + DE82 + B8575

MLSSA: Frequency Domain

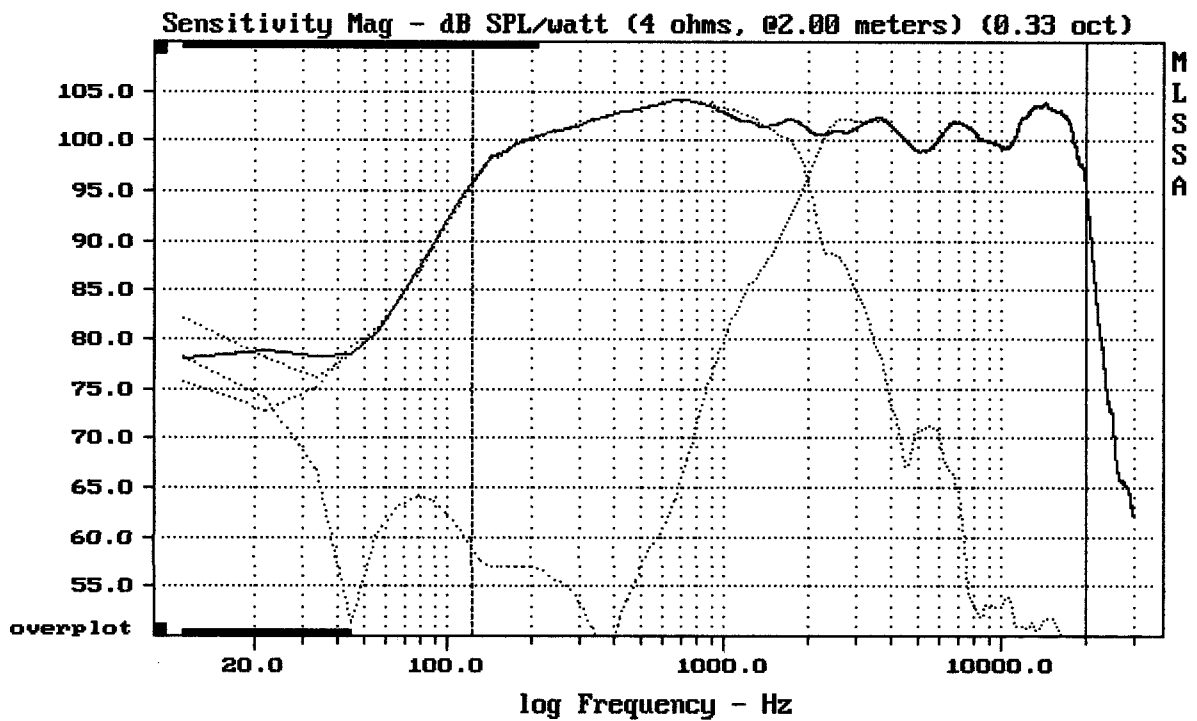

Level (122:20008 Hz) = 101.74 dB SPL/watt (4 ohms, @2.00 meters) (0.33 oct)

2x12PE32 + DE82 + B8575

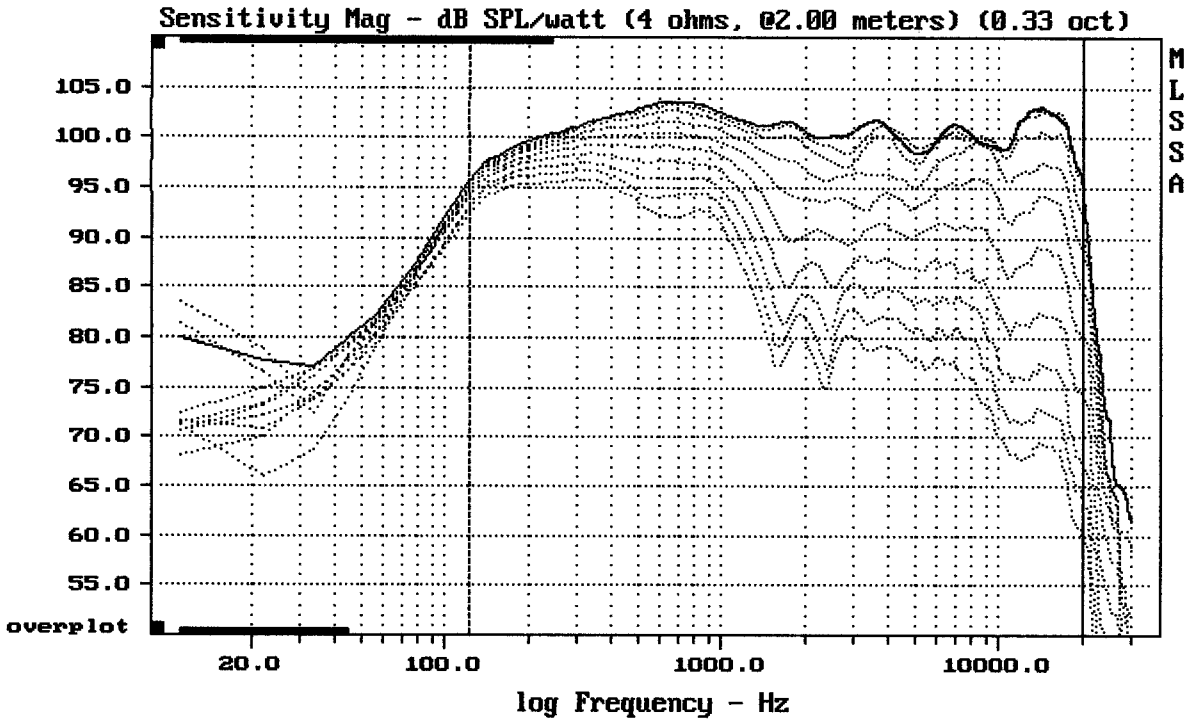

Overlay Compare: dev= +25/-8.8, std= 7.2, avg= -28

2x12PE32 + DE82 + B8575

MLSSA: Frequency Domain

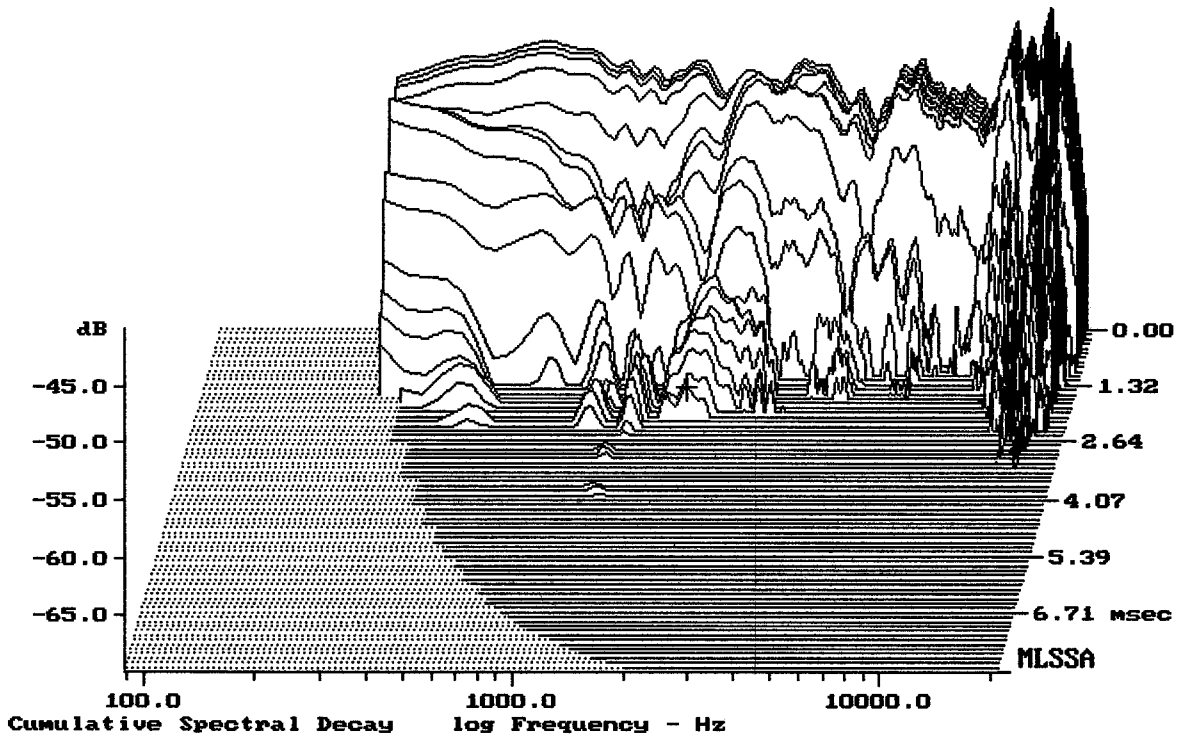

-67.30 dB, 1909 Hz (43), 2.090 msec (20)

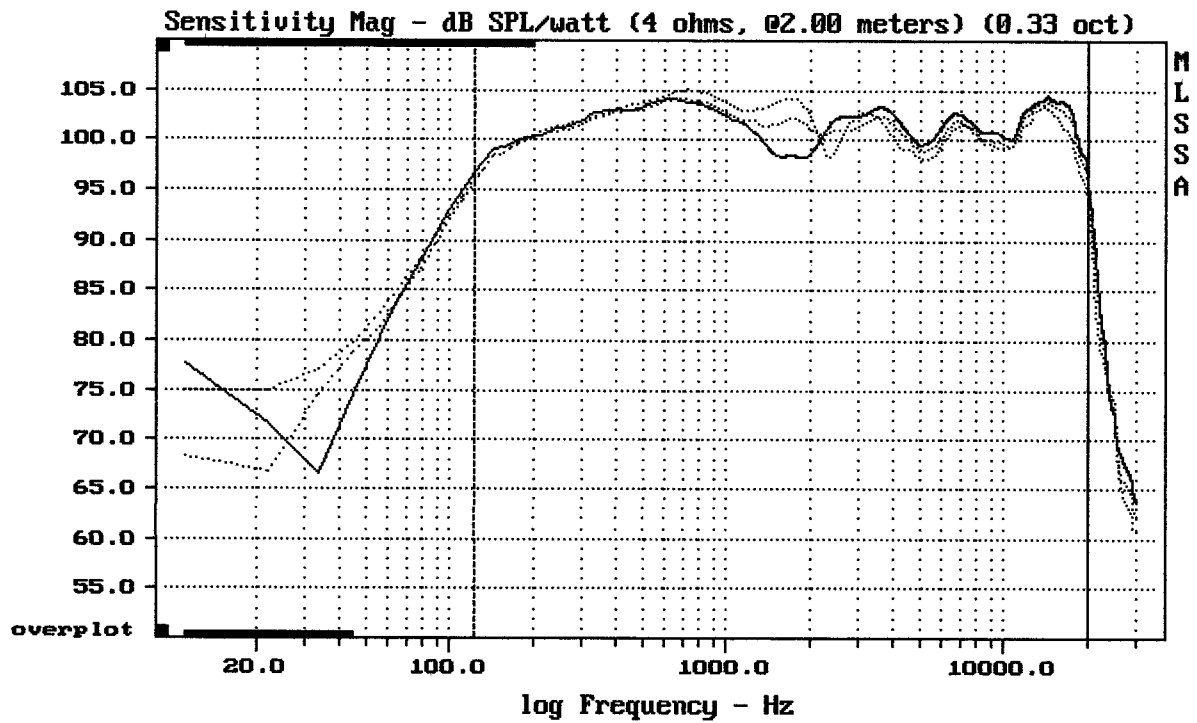

Overlay Compare: dev= +2.8/-1.9, std= 0.87, avg= -0.61

2x12PE32 + DE82 + B8575

MLSSA: Frequency Domain

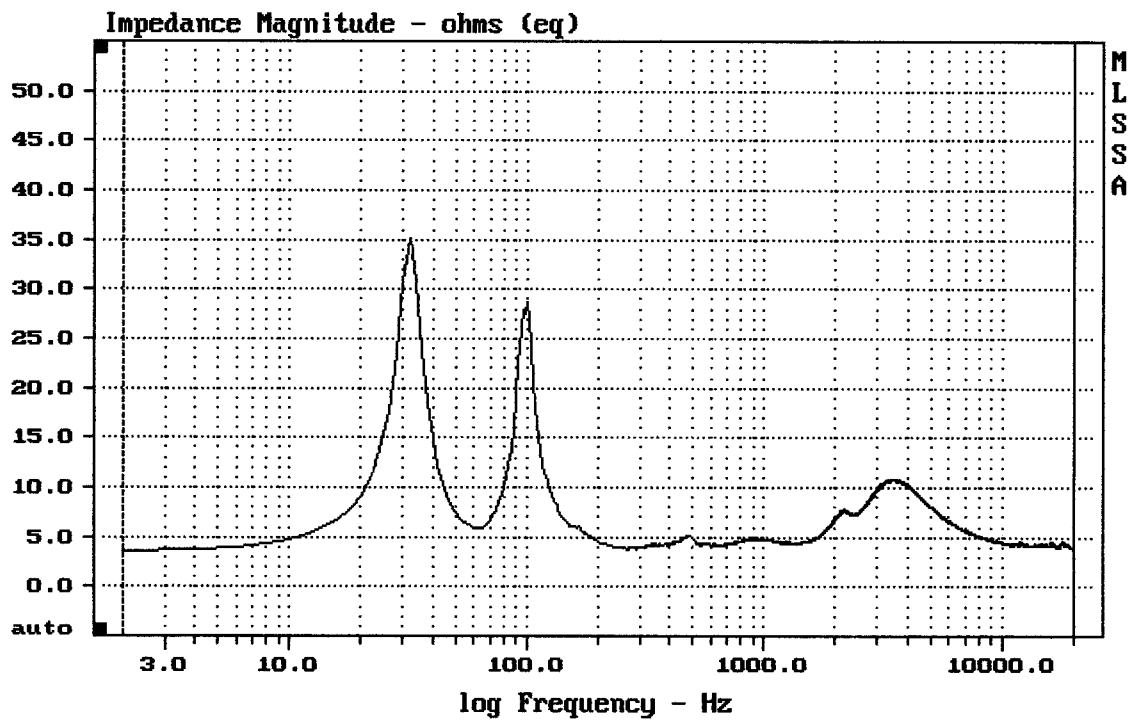

mean: 5.437, rms: 5.814, std: 2.058, max: 35.15, min: 3.57

2x12PE32 + DE82 + B8575